

SURTECO WORLDWIDE



- 20 production and sales locations
- 15 additional sales locations

SURTECO GERMANY

- Buttenwiesen-Pfaffenhofen
- Bönen
- Dunningen
- Gladbeck
- Halle (Saale)
- Heroldstatt
- Hüllhorst
- Laichingen
- Sassenberg
- Weimar
- Willich



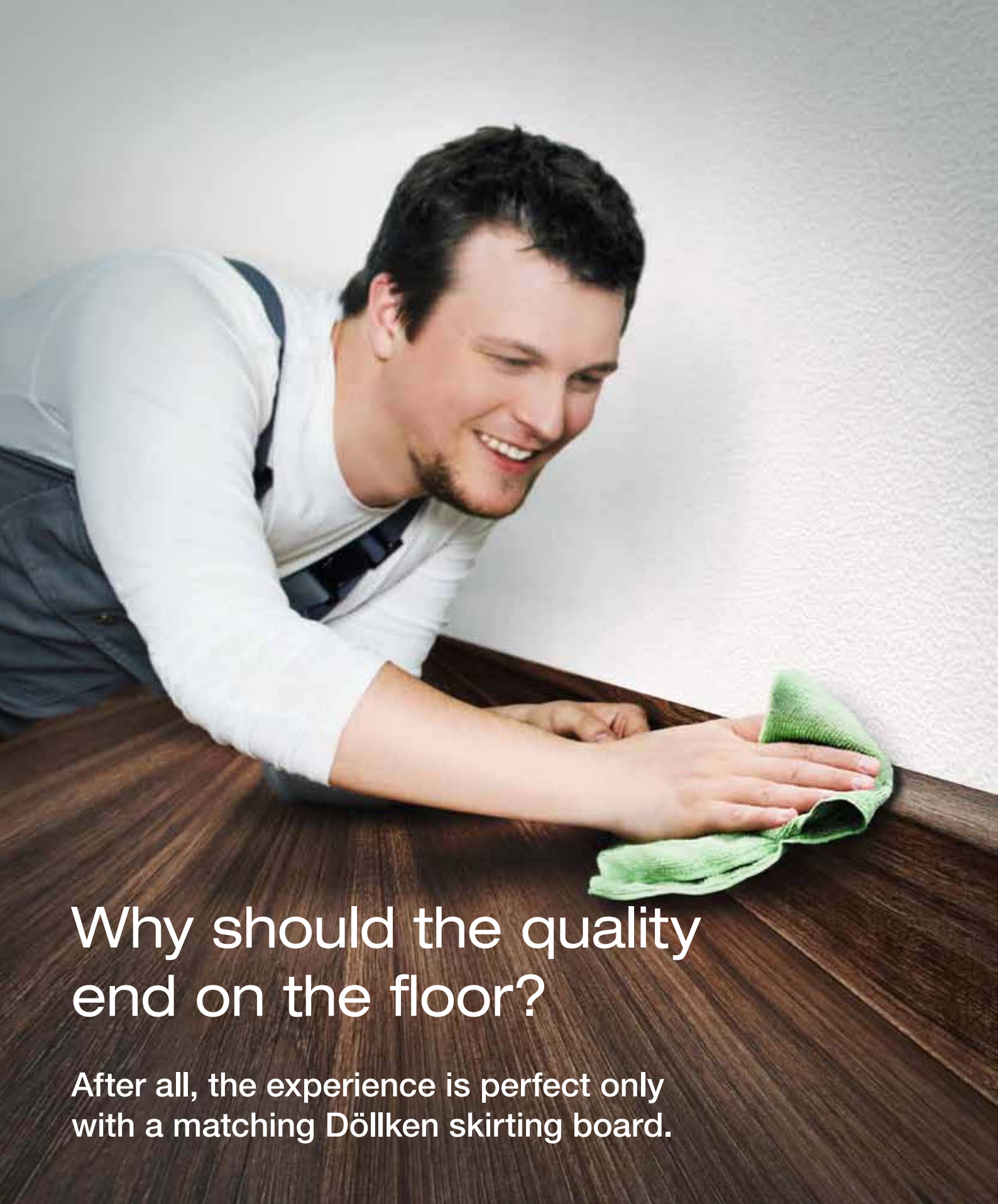

Why should the quality end on the floor?

After all, the experience is perfect only with a matching Döllken skirting board.

For durable LVT coatings there is only one choice: robust and quick to install skirting boards by Döllken-Weimar.



Döllken-Weimar Multimedia Assistant

NEW



Whether at home or on the move, the new Döllken-Weimar website is now optimized for mobile use. On our new platform you will find helpful information as well as tips and tricks about the use of skirting boards. Use our improved product and decor finder as well to quickly find the right skirting board for your requirements.

This and more on: www.doellkenweimar.de.

New icons in the application catalogue



This icon refers to new products and features.



This icon refers to products that were assigned to different category in this edition.

Ecology

Döllken is a manufacturer of health-friendly skirtings boards. Döllken-Weimar certifies its offering in accordance with demanding GREENGUARD GOLD standards covering low-emission products.

Housing and construction products that emit volatile organic compounds may lead to serious health issues.

GREENGUARD standards, recognized worldwide, are a good reference point when choosing low-emission products, and therefore healthy alternatives. Döllken-Weimar is the first manufacturer of skirtings, whose entire inventory is certified according to the restrictive guidelines of GREENGUARD GOLD.

For many years it has been commonplace to use plastics in the construction industry and in interior architecture. Testament to this are varied application fields, easy processing, long lifetime and good pricing. On the other hand, plastics often contain components that are potentially or actually harmful to health. The main areas of concern include vapours of volatile organic compounds, i.e. the so-called VOCs. They pollute the air in the room and may cause such illnesses as headaches, diseases of the respiratory system, eyes, nose, throat, or even cancer.

As a manufacturer of high-quality plastic products, such as skirtings and floor profiles, we treat this kind of issue very seriously. As the leading manufacturer in the industry, we have borne high costs in order to strictly test our products and receive the GREENGUARD certificate for low-emission products.

However, Döllken-Weimar was not satisfied with "standard" GREENGUARD testing, but opted instead for the highest level of testing called GREENGUARD GOLD. This option includes additional factors influencing security of particularly sensitive social groups, such as children or the elderly. Buyers responsible for selecting products for pre-schools, schools, health service facilities, and other clean facilities will always make the right choice by selecting our product. Using our products, one may create solutions that establish a good atmosphere. Using our products means creating a good, healthy atmosphere in rooms.

Appropriate research proves that air in closed rooms is often more polluted than the air outside, and most people spend 90% of their day in rooms. Since 2001, this issue has been addressed by the American Greenguard Environmental Institute (GEI). Standards defined by this institute strictly determine allowable densities for over 360 volatile organic compounds, as well as the allowable total value of all chemical emissions. These standards specify the highest levels for air quality in rooms, and their low-emission certificate is recognized worldwide.



Our products are tested using state-of-the-art technologies, such as high-performance chromatography, gas chromatography or mass spectrometry. The requirement for retaining this certificate is to regularly conduct and verify tests, our product range.

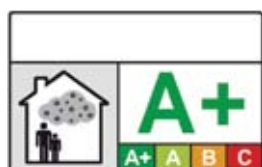

Be professional safe time and money

Döllken floor skirtings and profiles are ideally fit the requirements of professional floor fit-out works:

- **50% less work**

With Döllken tools you save half of your working time in comparison to conventional installation of foiled MDF skirtings, stamping, gluing - finishing.

- **Double cost advantage**

You save time during installation and can simultaneously achieve higher selling prices due to better product quality.

- **Complaints are a thing of yesterday**

No breaks, cuts or cracks in the skirting surface (not even on the corners). This means that no complaints arise from damaged or leaking corners and edges.

- **Perfect appearance without breaks**

Perfect optical results without unsightly fittings or accessories. No repainting or silicone required for the joints and corners. Clean working without dirt and chips.

Our recommendations regarding installation are presented in the form of pictograms:



Döllken
Mitre tool



Döllken
Scissors

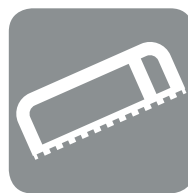

Saw



Döllken
Flooring cutter



Döllken
Clamp



Döllken
Hot-melt



UZIN adhesive tape



Nails



Contents

Solidcore skirtings 10-21

Exceptionally practical, ecological special solidcore

System floor skirtings 22-35

Esthetic and intelligent

Flexible floor skirtings 36-43

Walls and floors are in harmony with each other

Stair profiles and auxiliary profiles 44-55

Sturdy and reliable

Wooden skirting 56-65

High-quality wooden skirting from Döllken Weimar.

Kitchen worktop wall joint trims 66-69

Design and functionality

Tools 70-75

Quick and easy assembly and installation

Laminate underlays 76-81

Perfect utility insulation

Aluminium profiles 82-103

Universal perfection

Racks — Displays 104-109

Practical and attractive

Solidcore skirtings

System
floor
skirtings

Flexible
floor
skirtings

Stair profiles and
auxiliary profiles

Woodem skirting

Kitchen worktop
wall joint trims

Tools

Laminate
underlays

Aluminium profiles



Racks –
Displays





Special Solidcore skirtings

Exceptionally practical and green.

A convincing solution

Döllken solidcore skirtings are a one-of-a-kind solution. High-quality pine wood fibre cores with a FSC certificate are encased in resistant polymer, which guarantees their exceptional reliability. Döllken plinth blocks are particularly environmentally friendly and have a wide range of environmental certificates, e.g. GREENGUARD GOLD. They are extremely easy to use, and their installation helps save you time. All types of solidcore skirtings are subject to professional installation using system tools that do not require complicated, expert training courses.

	Product	Dimensions	Accessories	Installation recommendations	Page
	EP 60/13 flex life	H: 60 mm B: 13 mm L: 2,5 m		<ul style="list-style-type: none"> • Döllken cutter • Döllken hot-melt adhesive 	12
	S 60 flex life Top/ S 100 life	H: • 60 • 100 mm B: 15 mm L: 5,15 m	S 60 flex life Top: <ul style="list-style-type: none"> • UZIN adhesive tape • right and left end cap 	<ul style="list-style-type: none"> • Döllken cutter • Döllken hot-melt adhesive • UZIN adhesive tape (only S60 flex life Top) 	15
	S 66/22 flex life	H: 68 mm B: 22 mm L: 2,5 m	<ul style="list-style-type: none"> • right and left end cap 	<ul style="list-style-type: none"> • Döllken cutter • Döllken hot-melt adhesive 	16

	Product	Dimensions	Accessories	Installation recommendations	Page
	Cubu flex life/ Cubu flex life XL	H: • 40 mm • 60 mm • 80 mm • 100 mm B: • 12,6 mm • 19 mm L: 2,5 m	• fitting stone	• Döllken cutter • Döllken hot-melt adhesive	17
	Cubu flex life Premium				18
	D 60 life Top	H: 58 mm B: 10 mm L: 5,15 m	• right and left end cap • clamp	• Döllken cutter • Döllken hot-melt adhesive • UZIN adhesive tape • strip cutter	19
	C 60 life Top C 100 life	H: • 60 • 100 mm B: 15 mm L: 5,15 m	C 60 life Top: • right and left end cap	• Döllken cutter • Döllken hot-melt adhesive • UZIN adhesive tape (only C 60 life)	19 20
	TS 60 life Top TS 100 life	H: • 57 mm • 95 mm B: 13 mm L: 5,15 m	• right and left end cap	• Döllken cutter • Döllken hot-melt adhesive • UZIN adhesive tape (only TS 60 life Top)	20 21

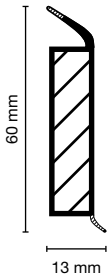

More than 300 decors

Find matching decor at www.doellken-weimar.de/en/products/decorfinder



Processing and installation recommendations



Döllken
Mitre tool



Döllken
Scissors



Döllken
Hot-melt
adhesive



Taśma
klejąca
UZIN

1 package = 10 x 2,50 m

- HDF core encased in a chlorine-free PP/TPE polymer with flexible edges in top and bottom parts
- the colour is a perfect fit (structure and decor) with the floor
- professional finish of the profile thanks to the functional use of a Mitre tool
- possibility of using any colour from the RAL palette for special orders from 500 running metres
- joint range 13-15 mm

Instructions for cutting finishing trims.

The EP 60/13 skirtings board does not require any additional accessories. Simple finishing trim using the Döllken Mitre tool. Perform the following actions:

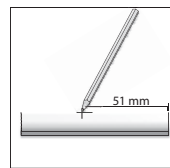

1. The skirtings board should be longer by 11 mm, then measure 51 mm from the end of the skirtings board.

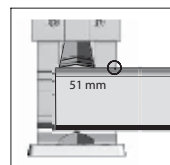

2. Cut the skirtings board according to item 1.

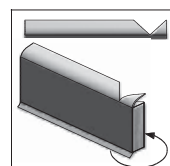

3. Assemble the end and apply adhesive.

See the
tutorial video



Product available on request.

Optional orders for special Decors from 500 linear metres. Please ask us for pricing!

EP 60/13 flex life decors – selection

1013 (0117)	2585 (W 585)	2374 (W 374)	2712 (W 712)	2607 (W 607)	2033	2556 (W 556)	2562 (W 562)	2629 (W 629)	2386 (W 386)	2374 (W 374)	2330 (W 330)	2485 (W 485)	2416 (W 416)
2370 (W 370)	2381 (W 381)	2368 (W 368)	2342 (W 342)	2011	2013	2719 (W 719)	2642 (W 642)	2711 (W 711)	2570 (W 570)	2715 (W 715)	2411 (W 411)	2417 (W 417)	2395 (W 395)
2572 (W 572)	2379 (W 379)	2418 (W 418)	2557 (W 557)	2385 (W 385)	2406 (W 406)	2726 (W 726)	2723 (W 723)	2717 (W 717)	2662 (W 662)	2329 (W 329)	2489 (W 489)	2334 (W 334)	2401 (W 401)
2580 (W 580)	1168 (436 A)	2383 (W 383)	2357 (W 357)	2399 (W 399)	2575 (W 575)	2486 (W 486)	2571 (W 571)	2625 (W 625)	2495 (W 495)	2614 (W 614)	2617 (W 617)	2615 (W 615)	2660 (W 660)
2491 (W 491)	2618 (W 618)	2564 (W 564)	2563 (W 563)	2632 (W 632)	2608 (W 608)	2609 (W 609)	2724 (W 724)	2714 (W 714)	2713 (W 713)	2341 (W 341)	2622 (W 622)	2384 (W 384)	2565 (W 565)
2574 (W 574)	2332 (W 332)	2602 (W 602)	2412 (W 412)	2413 (W 413)	2400 (W 400)	2567 (W 567)	2402 (W 402)	2389 (W 389)	2398 (W 398)	2358 (W 358)	2657 (W 657)	2626 (W 626)	2017
2664 (W 664)	2638 (W 638)	2490 (W 490)	2639 (W 639)	2627 (W 627)	2661 (W 661)	2369 (W 369)	2380 (W 380)	2423 (W 423)	2391 (W 391)	2365 (W 365)	2586 (W 586)	2356 (W 356)	2388 (W 388)
2375 (W 375)	2414 (W 414)	2599 (W 599)	2422 (W 422)	2336 (W 336)	2427 (W 427)	2333 (W 333)	2323 (W 323)	2554 (W 554)	2382 (W 382)	2600 (W 600)	2597 (W 597)	2360 (W 360)	2337 (W 337)
2424 (W 424)	2428 (W 428)	2487 (W 487)	2425 (W 425)	2494 (W 494)	2566 (W 566)	2430 (W 430)	2340 (W 340)	2339 (W 339)	2426 (W 426)	2372 (W 372)	2392 (W 392)	2322 (W 322)	2361 (W 361)
2569 (W 569)	2364 (364)	2415 (W 415)	2324 (W 324)	2335 (W 335)	2327 (W 327)	2631 (W 631)	2637 (W 637)	2636 (W 636)	2613 (W 613)	2403 (W 403)	2573 (W 573)	2328 (W 328)	2396 (W 396)
2672 (W 672)	2066 (W 666)	2408 (W 408)	2667 (W 667)	2603 (W 603)	2367 (W 367)	2407 (W 407)	2409 (W 409)	2633 (W 633)	2605 (W 605)	2616 (W 616)	2010	2673 (W 673)	2493 (W 493)
2004	2007	2656 (W 656)	2606 (W 606)	2658 (W 658)	2371 (W 371)	2595 (W 595)	2568 (W 568)	2394 (W 394)	2393 (W 393)	2363 (W 363)	2589 (W 589)	2331 (W 331)	2410 (W 410)
2587 (W 587)	2612 (W 612)	2366 (W 366)	2432 (W 432)	2326 (W 326)	2325 (W 325)	2377 (W 377)	2373 (W 373)	2584 (W 584)	2343 (W 343)	2420 (W 420)	2429 (W 429)	2718 (W 718)	2012
2497 (W 497)	2621 (W 621)	2 720 (W 720)	2634 (W 634)	2663 (W 663)	2611 (W 611)	2610 (W 610)	2338 (W 338)	2390 (W 390)	2362 (W 362)	2484 (W 484)	2598 (W 598)	2635 (W 635)	2628 (W 628)
2030	1019	2623 (W 623)	2555 (W 555)	2721 (W 721)	2498 (W 498)	2550 (W 550)	2499 (W 499)	2722 (W 722)	2630 (W 630)	2405 (W 405)	2020	1144 (0110)	2716 (W 716)

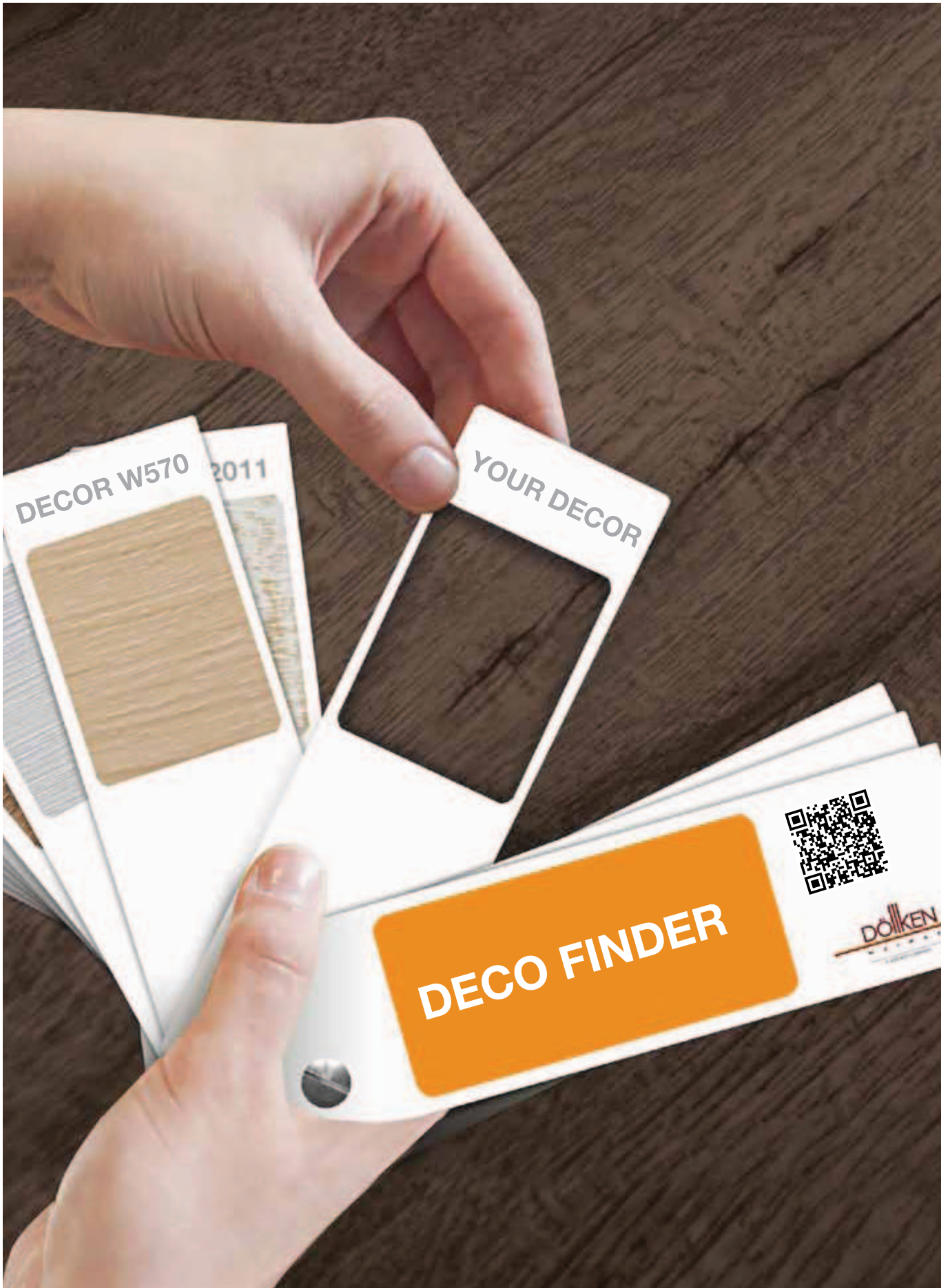

NOTE:

there is a match search on our website, you can use it to quickly find and appropriate EP 60/13 decor for most LVT floor collections present on the market.

S 60 flex life Top Solidcore skirting for all flooring types

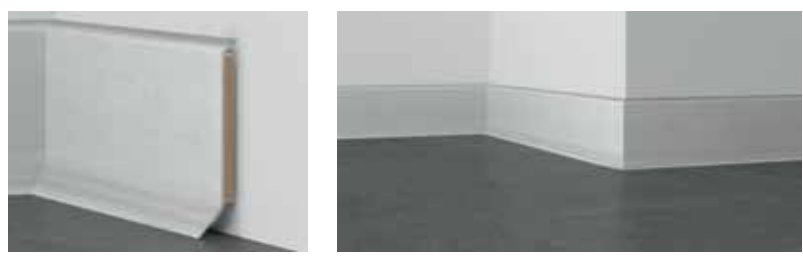
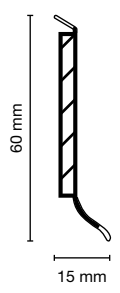

Processing and installation recommendations

- Döllken Mitre tool**
- Döllken Scissors**
- or
Döllken Hot-melt adhesive
- UZIN adhesive tape**



- 1 package = 20 x 2,57 m
- HDF core encased in a chlorine-free PP/TPE polymer with flexible edges in top and bottom parts
 - joint range 14-20 mm

Decors

1005 (1005) snow-white	1013 (5012) white	1152 (1312) metallic silver	1168 (436A) metallic aluminium	1145 (1248) white and grey	1012 (1202) light grey	1147 (1184) grey	1155 (3035) sea blue	1014 (4254) light beige	1148 (4244) beige	1006 (4035) terra	1082 (4019) brown
2718 (2718) anthracite	1144 (1001) black	2541 (D 089) maple	2629 (2629) white oak	2386 (2386) malua	2336 (2336) light fruit tree	2542 (D 058) light beech	2543 (D 255) light beech	2395 (2395) walnut island	2544 (D 132) natural oak	2357 (2357) stained oak	2329 (2329) smoked oak
2339 (2339) classic oak	2365 (2365) country oak	2360 (2360) fruit tree	2372 (2372) country cherry	2361 (2361) country cherry	2539 (D 260) cherry	2363 (2363) dark fruit tree	2587 (2587) traditional oak	2540 (D 130) macore	2362 (2362) rustic brown and grey	2371 (2371) stained teak	2547 (D 224) mahogany
2245 (W 207) antique walnut											

S 100 life Solidcore skirting for all flooring types

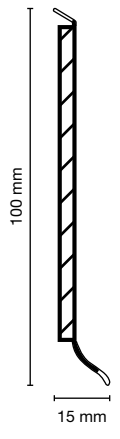

Processing and installation recommendations

- Döllken Mitre tool**
- Döllken Scissors**
- or
Döllken Hot-melt adhesive
- UZIN adhesive tape**

- 1 package = 10 x 2,57 m
- HDF core encased in a chlorine-free PP/TPE polymer with flexible edge in the bottom part
 - perfect replacement for flanging floorings in public utility facilities
 - joint range 14-20 mm



Decors

1013 (5012) white	1145 (1248) white and grey	1012 (1202) light grey	1014 (4254) light beige	1148 (4244) beige	1147 (1184) grey	1082 (4019) brown	1144 (1001) black	2542 (D 058) light beech	2545 (D 126) light oak	2540 (D 130) macore

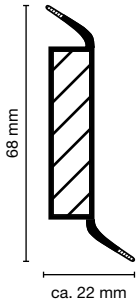

Processing and installation recommendations



Döllken
Mitre tool



Döllken
Hot-melt
adhesive

- 1 package = 10 x 2,5 m
- HDF core covered by chlorine-free PP/TPE-based polyblend with elastic lip seals to the wall and to the floor
- also available in back ventilated version

Accessories

(1 packaging = 10 pcs, on request as self-service packaging)



Left/ right end cap



Decors



Also available in back ventilated version

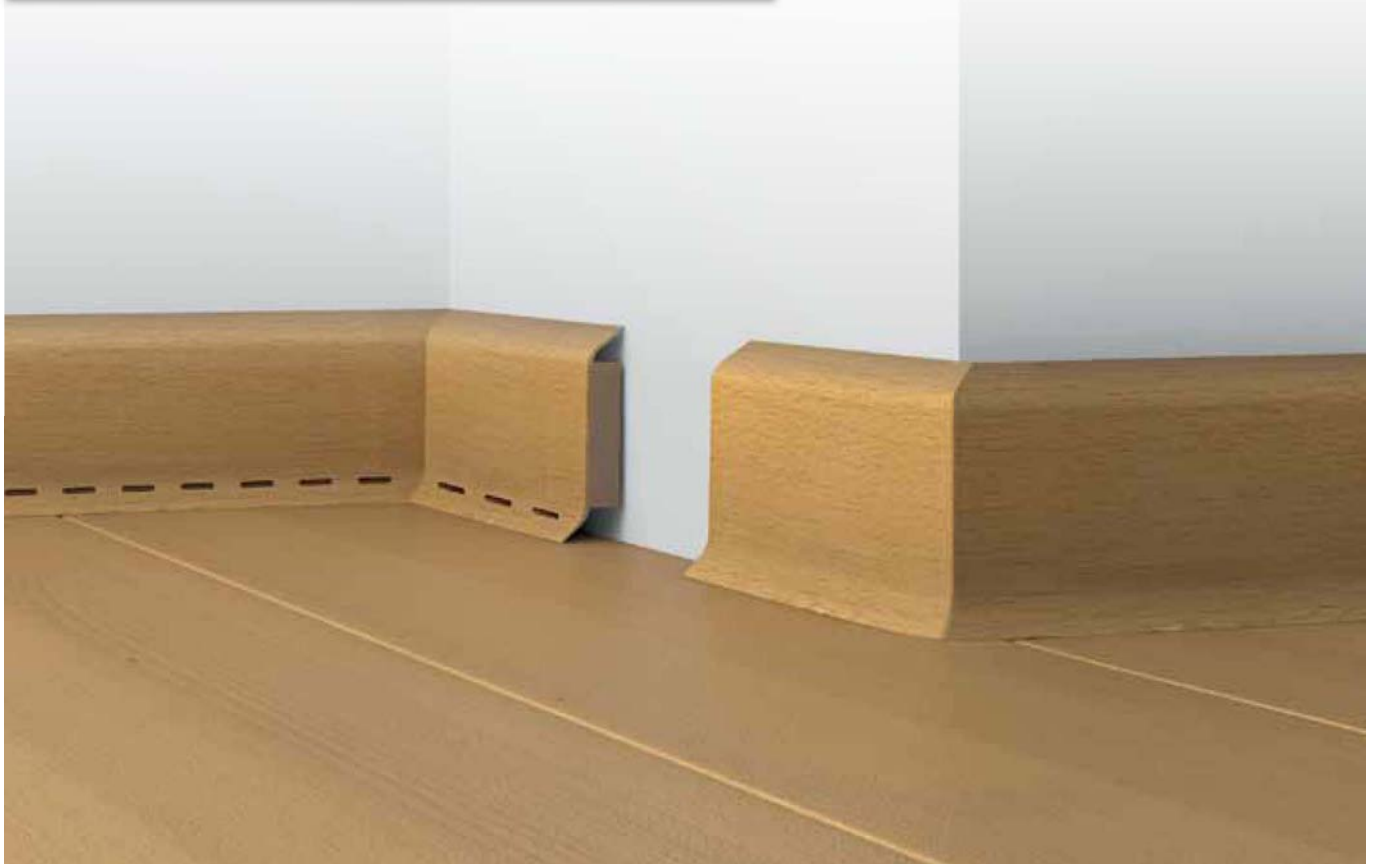

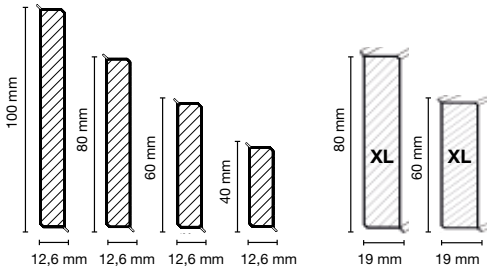
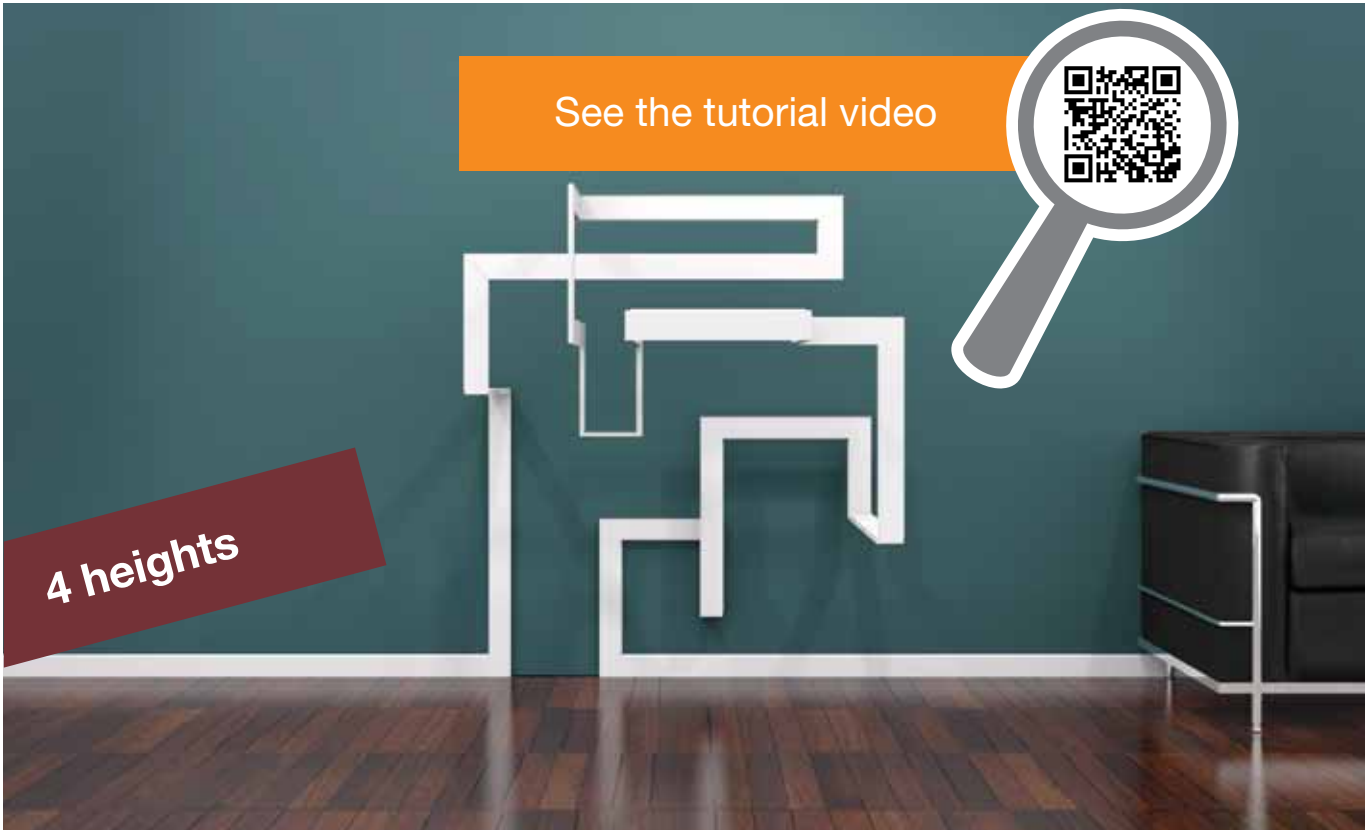

Assembly and installation recommendations



Döllken Mitre tool



Saw



Döllken Hot-melt adhesive



or UZIN adhesive tape

NOTE – additional clamp for the Mitre tool



Döllken Clamp XL



1 package = 10 pcs. x 2,50 m

Aesthetic and practical properties of the Cubu flex life plinth block form its substantial advantages in comparison with foiled MDF skirtings boards.

The Cubu flex life skirtings board is also available on the market made using a unique flocking process.



The most important advantages:

- quick and easy assembly using a Döllken Mitre tool and hot-melt adhesive. The Mitre tool creates a perfect internal and external angular profile, therefore it doesn't require any additional accessories
- assembly using Döllken hot-melt adhesive
- option to manufacture any RAL-palette colour on request from 1000 running metres

Additional accessories:



Small post

1 package = 2 pcs.



Large post

1 package = 2 pcs.

Decors



1013 (5012) white

1063 (W199) silver

1012 (1202) light grey



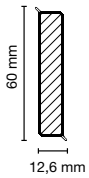

Assembly and installation recommendations



Döllken
Mitre tool



Saw



Döllken
Hotmelt

or



UZIN
adhesive
tape



1 package = 10 x 2.5 m

Design highlight for every floor

The Cubu flex life Premium skirting boards combines an outstanding genuine metal look with excellent installation features. With their precious metallic design e.g. copper, chrome or brushed stainless steel, they are suitable as a highlight and complement to various luxury floor tiles and laminate floors.



Fast installation due to the Döllken system tools*

The Cubu flex life Premium model can be die-cut. Edges and end caps can be formed directly from the skirting board. This method is not only quick but also visually appealing, since there are no breaks caused by open cutting edges, no silicon or moulded parts used.

Made of HDF core, a chlorine free full PP casing and SOFT PROTECTIVE RUBBER EDGES at the top and the bottom. They feature a genuine metal film finish. These are special impregnated papers, fully covered in stainless steel or copper

Tools

- universal die cutter from type 1001
- measuring templates
- edge cutter type 1001
- Döllken hot-melt adhesive gun HKP 220

Decors



1189
chrome

1193
copper

1192
brass

1191
champagne

1190
stainless



D 60 life Top Designer skirting boards for PVC, CV, lino and LVT floorings

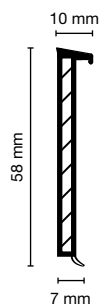

- Processing and installation recommendations**
- Döllken Mitre tool
 - Döllken Scissors
 - Döllken Cutter for flooring
 - Döllken Hot-melt adhesive
 - or UZIN adhesive tape



- 1 package = 20 x 2.57 m
- HDF core encased in a chlorine-free PP/TPE polymer with flexible edge
 - for interleaving a strip of flooring with maximum thickness of 4 mm
 - joint range 7 mm

Accessories



Cladding clamps for the Mitre tool used to cut skirtings boards and flooring

Decors

- | | | | | | | |
|-------------------|--------------------|--------------------|------------------------------|------------------------------|------------------------------|-------------------|
| | | | | | | |
| 1013 (5012) white | 1063 (W199) silver | 1084 (W 198) sandy | 1064 (W 201) silver and grey | 1083 (W 196) highgrade steel | 1091 (W 072) chocolate brown | 1144 (1001) black |

See the tutorial video

C 60 life Top Colour skirting boards for PVC, CV, lino and LVT floorings

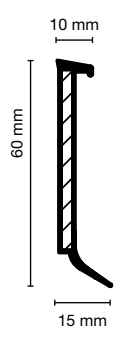

- Processing and installation recommendations**
- Döllken Mitre tool
 - Döllken Scissors
 - Döllken Cutter for flooring
 - Döllken Hot-melt adhesive
 - or UZIN adhesive tape



- 1 package = 20 x 2.57 m
- HDF core encased in a chlorine-free PP/TPE polymer with flexible edge
 - for interleaving a strip of flooring (width 40 mm, thickness up to 4 mm)
 - joint range 15-20 mm

Decors

- | | | | | | | | | | | | |
|-------------------|------------------------------|--------------------------|-------------------------|---------------------------|-------------------------|--------------------|------------------|--------------------------------|-----------------|-------------------|---------------------------|
| | | | | | | | | | | | |
| 1013 (5012) white | 1158 (5170) yellow | 1086 (W 074) light beige | 1008 (4115) light brown | 1159 (5993) metallic gold | 1010 (W 075) cappuccino | 1087 (W 073) brown | 1147 (1184) grey | 1168 (436A) metallic aluminium | 1168 (436A) red | 1157 (6028) green | 1165 (3037) metallic blue |
| | | | | | | | | | | | |
| 1156 (3020) blue | 1091 (W 072) chocolate brown | 1144 (1001) black | | | | | | | | | |

C 100 life

Colour skirting boards for PVC, CV, linoleum and luxury floors

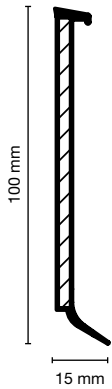

Processing and installation recommendations



Döllken or **Döllken**
Mitre tool **Hotmelt**

- 1 package = 10 x 5,15 m
- HDF core covered by chlorine-free PP/TPE-based polyblend with elastic lip seals to the wall and to the floor
- for gluing floor strips



Decors

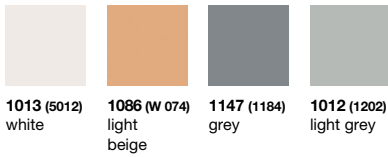

TS 60 life Top

Carpet skirting boards

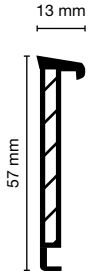

Processing and installation recommendations



Döllken or **Döllken**
Mitre tool **Scissors** **Hotmelt adhesive** **UZIN adhesive tape**

- 1 package = 20 x 2,57 m
- HDF core encased in a chlorine-free PP/TPE polymer with, with a cable duct
- for interleaving a strip of carpet flooring (width 57 mm, thickness up to 8 mm)



Decors

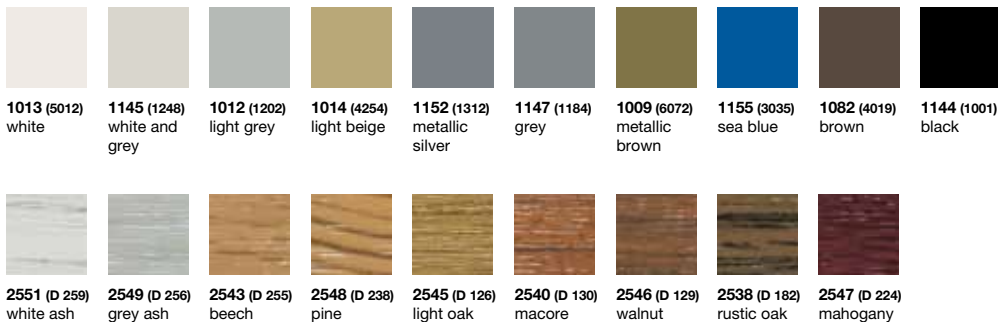

TS 100

Carpet skirting boards

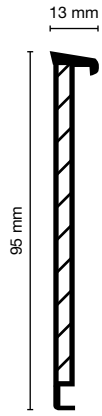

Processing and installation recommendations



Döllken
Mitre tool



Döllken
Scissors



or



Döllken
Hotmelt
adhesive

UZIN
adhesive
tape

1 package = 10 x 2,57 m

- HDF core encased in a PVC polymer (all materials used in the skirtings board comply with REACH regulations)
- for interleaving a strip of carpet flooring (width 95 mm, thickness up to 8 mm)



Decors



1013 (5012)
white



1012 (0138)
light grey



1147 (1184)
grey



1014 (4254)
light beige



1082 (4019)
brown



1144 (1001)
black



2545 (D 126)
light oak



2546 (D 129)
walnut



2538 (D 182)
rustic oak

System floor skirtings





Attractive and intelligent

Elegant shapes and practical details



Cover strips EL 3,5, EL 8, HK 15/15, 20/20, 25/25, and HK 100 Basic can be found now in the section on floor and special profiles on pages 51-62.

System skirtings boards arouse delight with their elegant look and unique properties. They include wide cable ducts, removable and replaceable decorative profiles, and they facilitate long-term renovations without the need to completely disassemble and replace skirtings boards.

	Product	Dimensions	Accessories	Installation recommendations	Page
	Quick MIG	H: 60 mm B: 20 mm L: 2,5 m	<ul style="list-style-type: none"> • inside corner 90° • outside corner 90° • left and right end cap • connector 	<ul style="list-style-type: none"> • Döllken hot-melt adhesive 	24
	SLK 50				25
	MD 63	H: 63 mm B: 26 mm		<ul style="list-style-type: none"> • Döllken hot-melt adhesive 	26
	USL 60				27



Solidcore skirtings

System floor skirtings

Flexible floor skirtings

Stair profiles and auxiliary profiles

Woodem skirting









Kitchen worktop wall joint trims

Tools

Laminate underlays

Aluminium profiles

Racks – Displays

	Product	Dimensions	Accessories	Installation recommendations	Page
	USL 60 clip				28
	HSL 6 / HSL 8 / HSL 10	H: 16/20 mm B: 15 mm L: 2,5 m		<ul style="list-style-type: none"> • Döllken cutter • Döllken hot-melt 	30
	TL 51				31
	TLE 55				31
	USL 50				32
	VELSANI				33
	RETRO				34
	RL 10				35
	DSL 60				35

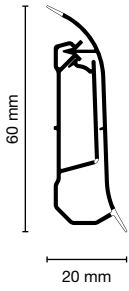

Installation recommendations



Döllen
Hot-melt
adhesive

or
Wall
plugs

1 package = 10 x 2.50 m

Accessories:



Internal angular profile
1 package = 2 pcs.



External angular profile
1 package = 1 pcs.



Right + left finishing trim



Fastener
1 package = 2 pcs.

- optional installation using plugs, nails or adhesive
- perform room renovating works without completely disassembling the skirtings board
- the integrated cable duct is also present in external and internal angular profiles
- perfect fit against the wall and floor due to flexible edges in the top and bottom parts of the skirtings board



Decors



1137 (0119) white
1436 (436A) metallic aluminium
2183 (W707) rustic oak
2136 (W463) masala oak
2137 (W464) husky oak
2118 (W212) old oak
2182 (W706) Celtic oak
2181 (W705) belini oak



2080 (W129) vosges oak
2124 (W275) wine oak
2080 (W704) smoked oak
2179 (W702) sutter oak
2123 (W274) Roman oak
2184 (W708) natural walnut
2185 (W709) dark acacia



See the tutorial video



QUICK
MIG

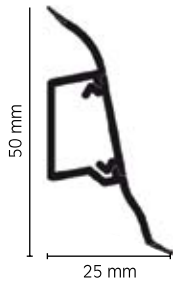

Installation recommendations



Döllen
Hot-melt
adhesive

Wall
plugs



1 package = 40 x 2,50 m

- using PVC materials, with a cable duct and soft edges adjacent to the wall and the floor
- removable belt of the external profile in order to easily put cables through the skirtings board

Accessories

1 package = 25 pcs.



Internal
angular

External
angular

Right
finishing trim

Left
finishing trim

Fastener

Decors

1137 (W 117) white	0110 (110) black	1436 (436 A) aluminum	2082 (W 131) crystal ash	2083 (W 132) Newport maple	2093 (W 165) ahorn select	2100 (W 172) Queensland acacia	2122 (W 217) olive walnut	2089 (W 137) Amerang beech	2099 (W 171) Oak rustic	2097 (W 169) corona beech	2084 (W 133) Memphis cherry
2087 (W 136) yellow beech	2101 (W 173) woodstock white	2142 (W 469) Siberian ash	2126 (W 277) mountain apple tree	2137 (W 464) Essential line Husky Oak	2140 (W 467) Massive Labrador	2136 (W 463) helio masala oak	2118 (W 212) oak old	2085 (W 134) dark beech	2143 (W 470) Flavour line Brazilian Oak	2105 (W 177) Canadian spruce	2134 (W 461) strong shiro oak
2152 (W 481) balearic oak	2132 (W 459) Superior line Bergen Oak	2117 (W 211) Cordoba oak	2107 (W 179) Oak windsor	2094 (W 166) oak antique	2120 (W 214) California cyprus	2096 (W 168) oriental walnut	2098 (W 170) hawthorn	2121 (W 216) Maranello oak	2108 (W 180) golden oak	2110 (W 182) Lugano maple	2111 (W 183) Oak Montana
2080 (W 129) Vosges oak	2115 (W 185) golden acacia	2116 (W 187) Bosco pear	2114 (W 184) picota cherry	2081 (W 130) Canadian Oak	2089 (W 138) Oxford cherry	2125 (W 276) Virginia walnut	2123 (W 274) Romanian oak	2102 (W 174) doussie	2086 (W 135) country cherry	2091 (W 140) natural walnut	2141 (W 468) Progress Celtic Oak
2147 (W 474) valentino Antique oak	2148 (W 475) authentic walnut	2124 (W 275) wine oak	2146 (W 473) Sicily Valentino pinia	2129 (W 280) cottage oak	2161 (W 650) oak bourbon	2090 (W 139) walnut tree	2092 (W 161) dark acacia	2095 (W 167) merbau	2103 (W 175) pangapanga	2128 (W 279) dark brown walnut	2151 (W 479) Corsican oak
2156 (W 645) walnut	2135 (W 462) Strong Line Tamar Oak	2139 (W 466) magnus oak	2144 (W 471) valentino pina abruzza oak	2150 (W 478) Sardinian oak	2155 (W 644) scotch pine	2157 (W 646) stockholm ash	2159 (W 648) white oak	2165 (W 653) veranda	2160 (W 649) diamond oak	2130 (W 281) Vintage acacia	2158 (W 647) stirling oak
2145 (W 472) valentino Graphite Pecano	2149 (W 476) Wenge	2154 (W 643) nothern pine new	2164 (W 652) spruce bronholm	2131 (W 458) massive negro oak	0146 (146) dark grey	2104 (W 176) palace oak	2133 (W 460) helio Cardamom oak	2109 (W 181) wenge kibolo	2127 (W 278) dark atzelia	2138 (W 465) Viking oak	2106 (W 178) african zebra
2119 (W 213) Valencia walnut											

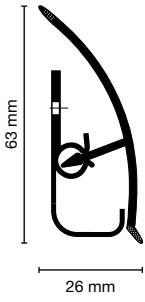

Installation recommendations



Döllken
Hot-melt
adhesive

or
Wall
plugs



1 package = 20 x 2,50 m

- 63 mm high profile, especially beneficial during renovations
- the skirtings board is composed of the MD 63 decorative profile and the GP 20 installation profile from a PS or PP-based chlorine-free polymer
- exceptionally wide cable ducts

Product available on request.

Decors

1129 (0117) white	2276 (W 043) maple	2281 (W 117) oak limed	2153 (W 483) white oak	2278 (W 115) light acacia	2280 (W 042) natural beech	2285 (W 046) light cherry
1128 (0138) light grey	1436 (436A) alu metallic	2194 (2194) old ash	2279 (W 041) dark beech	2282 (W 044) light oak	2286 (W 056) cork	2283 (W 110) cherry tree
2284 (W 109) antique cherry	2289 (W 116) brown walnut	2288 (W 111) elm tree	2193 (2193) antique oak	2290 (W 703) walnut	2287 (W 112) merbau	2113 (W 113) afzelia
2190 (2190) solid oak	2277 (W 114) dark acacia	2162 (W 162) dark wenge				

Accessories

1 package = 10 pcs.



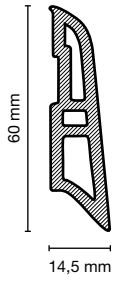

Installation recommendations



Döllken
Hotmelt

• 1 package = 10 x 2.5 m

• made of foamed PVC-based polyblend
(all ingredients are REACH compliant)

Accessories

(1 packaging = 10 pcs, available in 8 Decors, see Table)



Decors

1129 (0117) white	2644 (W189) Canadian maple	2199 (W190) light beech	2186 (41) grey ash	1436 (436A) alumetallic	2643 (W270) damped beech	2036 Canadian pine
2041 (2041) mountain oak	2038 (2038) white oak	2169 (W271) oak	2166 (2034) colorado oak	2057 (2040) niagara hemlock	2074 (W671) Rio cherry	2079 (660 N) beech
2073 (22) walnut	2037 florida pine	2039 (2039) brown oak	0110 (110) black			

Non-binding recommendation of decor combination*

USL 60	Accessories
white	plain white
Canadian maple	plain beech
light beech	plain beech
grey ash tree	plain grey
alumetallic	silver metallic
damped beech	plain beech
Canadian pine	plain grey/plain white
mountain oak	plain gray
white oak	plain gray
oak	plain oak
colorado oak	plain rustic
niagara hemlock	plain rustic
Rio cherry	plain rustic
beech	plain beech
walnut	plain antique
florida pine	plain gray/plain black
brown oak	plain rustic
black	plain black

*Mitre saw for a uniform decorative design.

Current range
of designs

offers a great selection of products
and expands continuously.

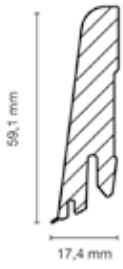

Installation recommendations



Döllken
Hot-melt
adhesive



Döllken
Scissors



ClipStar
metal



1 package = 10 x 2,50 m

- foamed PVC polymer
(all materials used in the skirtings board comply with REACH regulations)

Accessories

(1 packaging = 10 pcs, available in 8 Decors, see Table)



Inside corner 90°



Outside corner 90°



Left and right
end caps

Decors

2680 Assisi	2684 Malta	2681 Geneva	2683 Mykonos	2682 Corsica	2679 Rome	2654 Brixen/ Zermatt oak	2592 Braunwald oak	2318 Morgins pine	2685 white golden oak	2677 Valles oak	2348 Simmertal oak
2433 Kiental oak	2686 honey golden oak	2655 Torgon oak	2166 Bondone/ Avers oak	2709 golden smoked	2687 natural golden oak	2647 Verde/ Feldis oak	2678 Champery oak	2676 Engelbert oak	2675 smoked power oak	2688 Sicily	2734 grey smoked oak

Non-binding recommendation of decor combination*

HSL Modern 60 Clip	Accessories	
	inside corners	outside corners
Rome	grey	silver
Assisi	grey	silver
Genova	grey	Champagne
Sicily	grey	silver
Corsica	grey	silver
Mykonos	grey	silver
Malta	silver	grey
golden oak white	oak	bronze
golden oak honey	oak	Champagne
golden oak natural	light oak	bronze
smoky oak pewter	grey	silver
smoky oak gold	oak	grey
smoky oak gray	silver	grey
Brixen/Zermatt oak	silver	grey
Verde/Feldis oak	oak	light oak
Kiental oak	light oak	Champagne
Vallees oak	light oak	Champagne
Engelbert oak	light oak	Champagne
Champery oak	light oak	Champagne
Braunwald oak	silver	grey
Morgins pine	grey	Champagne
Torgon oak	grey	silver
Simmertal oak	oak	Champagne
Bondone/Avers oak	oak	light oak

*Mitre saw for a uniform decorative design.





Installation recommendations



Döllken Mitre tool



Saw



Döllken Hot-melt adhesive



Döllken Scissors

HSL 6

1 package = 20 x 2,50 m

HSL 8

1 package = 20 x 2,50 m

HSL 10

1 package = 20 x 2,50 m

- with foamed PVC
(all materials used in the skirtings board comply with REACH regulations)

Product available on request.

i **HSL 6 – new redesigned version**
for more flexibility during the installation

Decors HSL 6

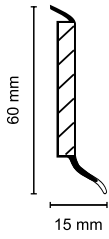

1135 (W 194) white	1074 (W 692) silver	1088 (W 239) light beige	1051 (W 222) grey	1109 (W 257) blue and green	1110 (W 251) blue	1049 (W 224) dark grey	1111 (W 252) dark blue	1048 (W 226) dark brown	0110 (W 225) black
2202 (W 265) silver and grey	2198 (89) maple	2219 (W 694) chestnut	2217 (W 691) rustic oak	2273 (W 266) beech	2221 (W 696) antique fir	2216 (W 690) ramin	2224 (W 699) bomanga	2223 (W 698) padauk	2222 (W 697) Icarus
2171 (30) dark oak	2220 (W 695) fucus	2225 (W 700) mahogany	2218 (W 693) chocolate wenge						

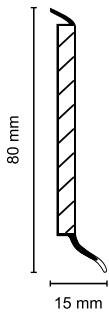

Decors HSL 8

1135 (W 194) white	2198 (89) maple	2202 (W 265) silvergrey	1088 (W 239) light beige	1051 (W 222) grey	2273 (W 266) beech	2171 (30) dark oak	1049 (W 224) dark grey	1048 (W 226) dark brown	2245 (W 207) antique walnut	2220 (W 695) sea oak	0110 (W 225) black

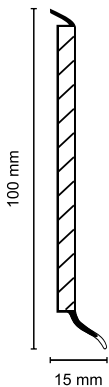

Decors HSL 10

1135 (W 194) white	1088 (W 239) light beige	1051 (W 222) grey	1048 (W 226) dark brown	1049 (W 224) dark grey	0110 (W 225) black

TL 51

Ribbed carpet skirtings board with strong adhesive for fixing flooring strips

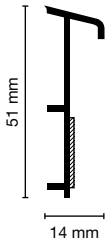

Installation recommendations



Wall plugs



Döllken Scissors

System floor skirtings



1 package = 25 x 4,00 m – upon request
1 package = 20 x 2,50 m – standard Decors

- PVC polymer (all materials used in the skirtings board comply with REACH regulations)
- for interleaving a strip of flooring (width 50 mm, thickness up to 8 mm)

Accessories

1 package = 10 pcs.



Internal angular



External angular



Left finishing trim



Right finishing trim

Standard Decors

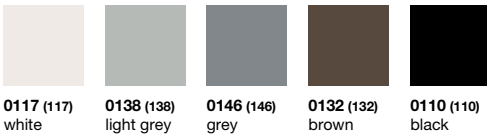

Decors available on request



TLE 55

Flat carpet skirtings board with strong adhesive for fixing flooring strips

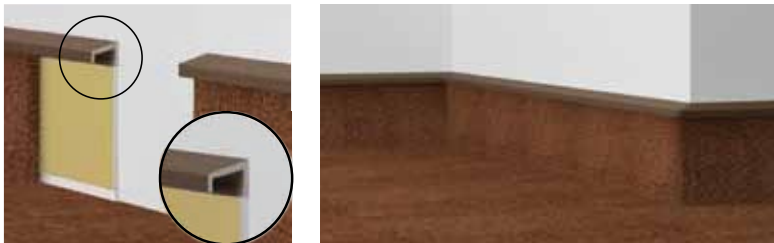
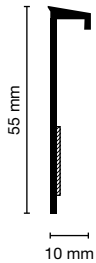

Processing recommendations



Döllken Scissors

or



UZIN adhesive tape



1 package = 20 x 2,50 m

- PVC polymer (all materials used in the skirtings board comply with REACH regulations)
- flexible upper part of the skirtings board
- for interleaving a strip of flooring (width 54 mm, thickness up to 7 mm)
- special adhesive strip placed on the skirtings board during its manufacture

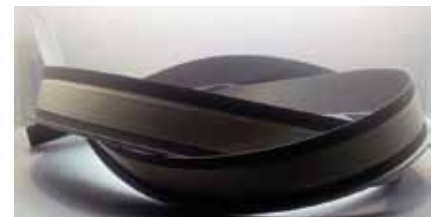

Standard Decors

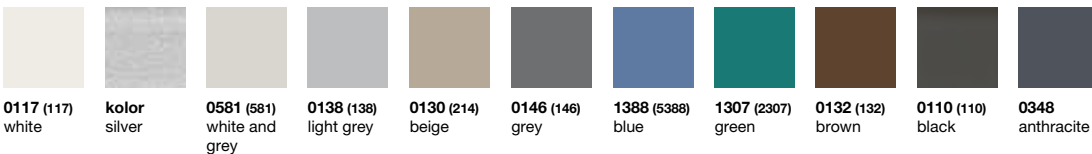

Decors available on request

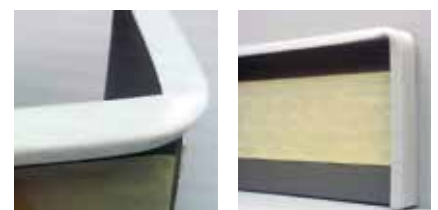
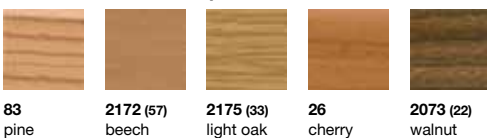

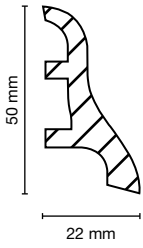

Processing recommendations



Mounting Clip FH/SB
 (FH 1 sales unit = 2500 pieces,
 SB = 10 x 20 pieces)

USL 50:

1 sales unit = 40 x 2.50 m

• expanded polyblend based on PVC
 (all content conforms to REACH),
 for all kind of floorings, ideal for laminate floors

Accessories

(1 sales unit = 10 pieces)



Internal corners
(printed)



External corners
(printed)



End caps left/right
(printed)



Connectors
(printed)

Decors



1137 (117)
white



2244 (61)
ash white



2198 (89)
maple



2186 (41)
grey ash



2226 (58)
light beech



0138 (138)
light grey



2213 (8876)
stone



2230 (658N)
pinewood
antique



2238 (85 B)
pinewood



2232 (60)
pale beech



2231 (657N)
beech
natural



2174 (659N)
light oak



2171 (30)
dark oak



2210 (656N)
alder



2208 (655N)
cherry
antique



0873 (873 A DC)
pink



2229 (69 B DC)
green



2228 (68 B DC)
blue



2079 (660 N)
beech



2170 (26)
cherry



2209 (644 L)
oak antique



2214 (735 J)
amber oak



2073 (22)
walnut



2215 (54)
mahogany



0110 (110)
black

RL 10

Renovation Skirting Board for textile floor coverings

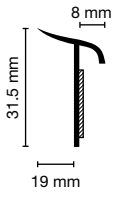

Processing recommendations



Nails

1 sales unit = 25 x 2.50 m

- made of polyblend based on PVC (all content conforms to REACH), for the renovation of existing skirting boards, for self-adhesive carpet infills

Decors



0117 (117)
white



0581 (581)
white grey



0138 (138)
light grey



2175 (33)
light oak



2073 (22)
walnut

DSL 60

Elastyczna listwa cokołowa do wykładzin PVC, CV, linoleum oraz LVT

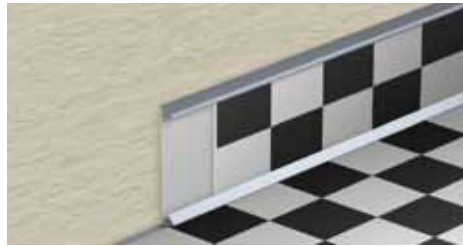
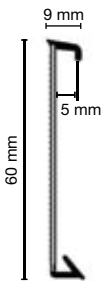

Processing recommendations



Döllken
Mitre tool



Döllken
Scissors



Döllken
Hot-melt
adhesive



or
UZIN
adhesive
tape

1 package = 40 x 2,50 m

- easy and quick installation process without fit-out
- perfectly flexible, for curves, columns and all irregular surfaces
- great designer possibilities with respect to using PVC to fit out floors
- flexible edges holding the decorative flooring strip
- external angles trimmed using a Mitre tool with special overlays
- installation of skirtings boards in corners only after fixing the flooring strip inside (width 60 mm, thickness up to 5 mm)

Accessories



Cladding clamps for the Mitre tool used to cut skirtings boards with strips of flooring



Decors



1137 (117)
white



1063 (W 199)
silver



1084 (W 198)
sandy



1064 (W 201)
silver
and grey



1083 (W 196)
high-grade
steel



1091 (W 072)
chocolate
brown







Processing recommendations



**Döllken
Hotmelt**

1 package = 18 pcs.

- floor and decorative Velsani skirtings are manufactured using a strong HD polymer
- besides their high resistance to shock, Velsani skirtings boards are also water resistant, which enables their use in facilities with high humidity and direct contact with water.
- special trimming of skirtings boards enables their quick installation using adhesive, and hiding cables.
- the skirtings boards can be painted using acrylic and water-based paints.

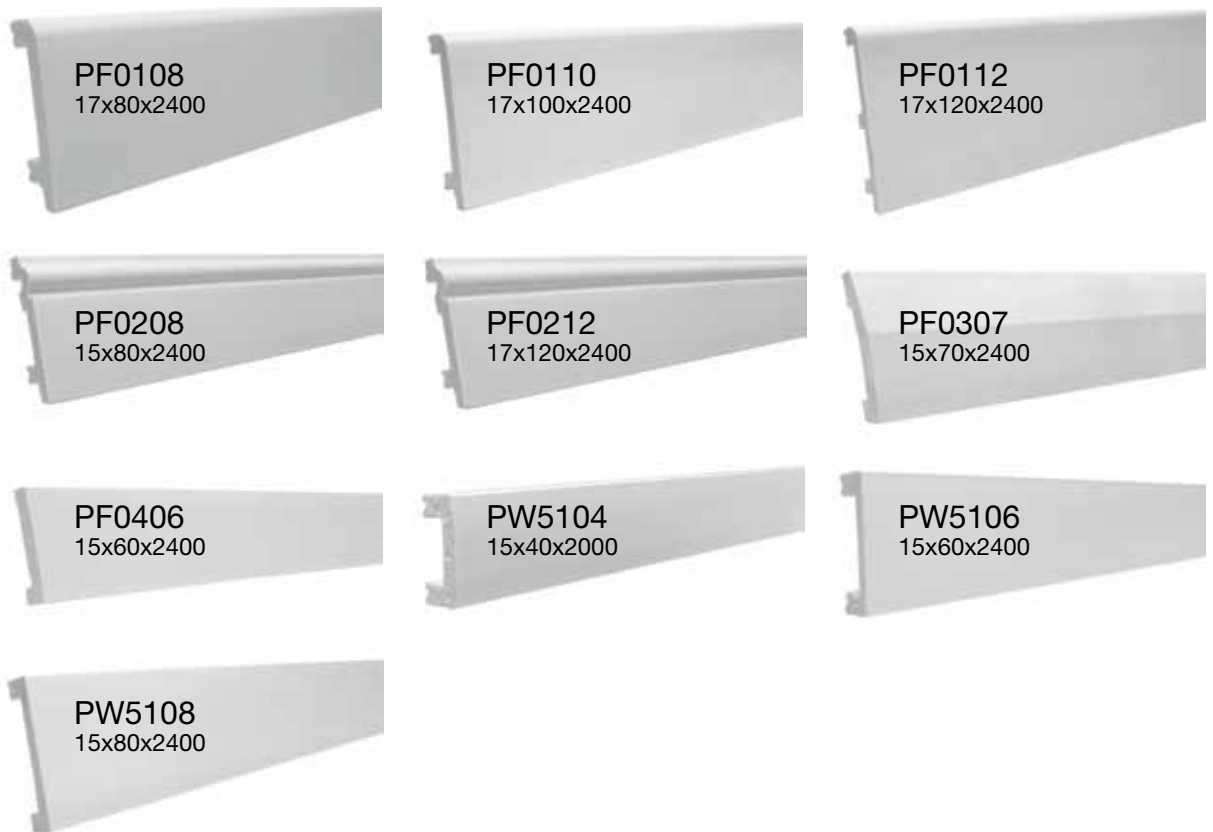

Fit-out accessories:

Universal post

1 package = 1 pc.



Flexible floor skirtings





Walls and floors are in harmony with each other

The easiest method for quickly performing a fit-out of the floor

Flexible floor plinth blocks are particularly well suited to use together with flexible PVC floorings.

Their installation is quick and easy, and the connection between wall and floor harmonious. These plinths comply with the REACH regulation and do not contain harmful softening agents.



	Product	Dimensions	Installation recommendations	Page
	WL 50	H: 50 mm B: 12 mm L: 50 m (rolled)	• UZIN adhesive tape	38
	WL 50 life	H: 50 mm B: 12 mm L: 50 m (rolled)	• UZIN adhesive tape	38
	WLK 50	H: 50 mm B: 12 mm L: 50 m (rolled)	• self-adhesive UZIN tape	39
	WLK 50 life	H: 50 mm B: 12 mm L: 50 m (rolled)	• self-adhesive UZIN tape	39

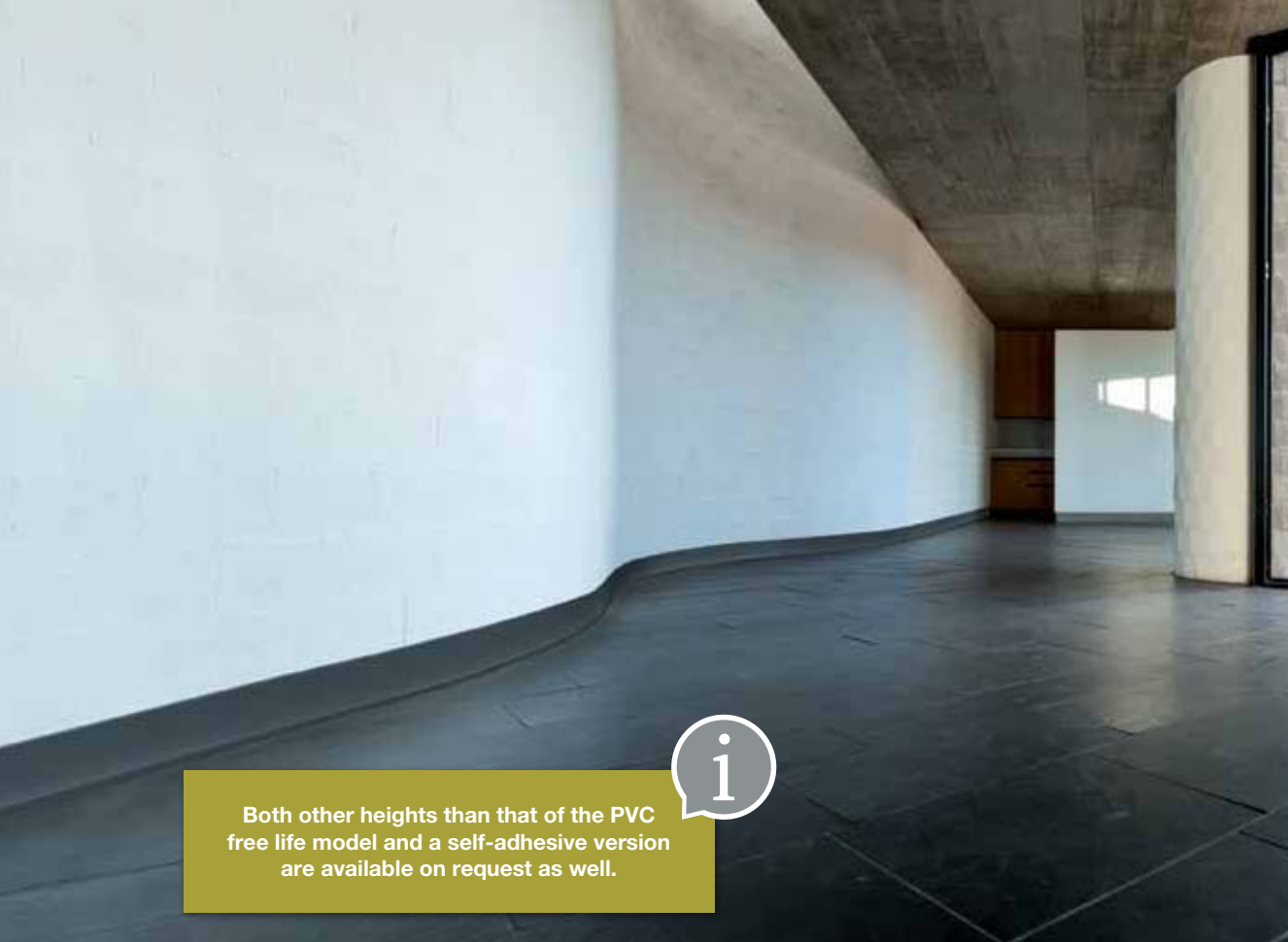

Both other heights than that of the PVC free life model and a self-adhesive version are available on request as well.

Solidcore skirtings

System floor skirtings

Flexible floor skirtings

Stair profiles and auxiliary profiles

Woodem skirting







Kitchen worktop wall joint trims

Tools

Laminate underlays

Aluminium profiles

Racks – Displays

	Product	Dimensions	Installation recommendations	Page
	WL 60	H: 60 mm B: 15 mm L: 50 m (rolled)	• UZIN adhesive tape	40
	WL 60 life	H: 60 mm B: 15 mm L: 50 m (rolled)	• UZIN adhesive tape	40
	WLK 60	H: 60 mm B: 15 mm L: 50 m (rolled)	• self-adhesive UZIN tape	41
	WLK 60 life	H: 60 mm B: 15 mm L: 50 m (rolled)	• self-adhesive UZIN tape	41
	WL 80	H: 80 mm B: 17 mm L: 25 m (rolled)		42
	WL 100	H: 100 mm B: 20 mm L: 25 m (rolled)		42
	WLK 20	H: 19 mm B: 19 mm L: 25 m (rolled)	• self-adhesive UZIN tape	43

WL 50

Skirting boards for PVC, CV and linoleum floors



Installation recommendations



UZIN
adhesive
tape

• 1 packaging = 1 x 50 m (rolled)

made of PVC-based polyblend (all ingredients are REACH compliant)

Decors (special decors available from 500 m, price upon request!)

1137 (117) white	0878 (878) blue-grey	0880 (880) stone grey	0138 (138) light grey	0915 (915) light grey	0875 (875) sandy brown	0913 (913) light beige	0914 (914) dark beige	0879 (879) hazel	0130 (130) beige	0420 (420) parquet
1388 (5388) blue	1069 (121) grey	0146 (146) dark grey	0132 (132) brown	0348 (348) anthracite	0110 (110) black	2771 (61) white ash	2186 (41) grey ash tree	2236 (W 258) light beech	2175 (33) light oak	2172 (57) beech

WL 50 life

Skirting boards for PVC, CV and linoleum floors



Installation recommendations



UZIN
adhesive
tape

TCF
totally
chlorinefree

• 1 packaging = 1 x 50 m (rolled)

- made of elastic chlorine-free PP/TPE based polyblend
- chlorine-free and plasticizer-free

Decors

1137 (117) white	0138 (138) light grey	2236 (W 258) light beech	0130 (130) beige	0914 (914) dark beige	0913 (913) light beige	0879 (879) hazel
1069 (121) grey	0146 (146) dark grey	0348 (348) anthracite	0110 (110) black	2175 (33) light oak	2172 (57) beech	



- 1 packaging = 1 x 50 m (rolled)
- made of PVC-based polyblend (all ingredients are REACH compliant)
- self-adhesive equipped with the UZIN adhesive tape

Decors

1137 (117) white	0138 (138) light grey	2236 (W 258) light beech	0130 (130) beige	0914 (914) dark beige	0913 (913) light beige	0879 (879) hazel
1069 (121) grey	0146 (146) dark grey	0348 (348) anthracite	0110 (110) black	2175 (33) light oak	2172 (57) beech	

Flexible floor skirtings



- 1 packaging = 1 x 50 m (rolled)
- made of elastic chlorine-free PP/TPE-based polyblend
- chlorine-free and plasticizer-free
- self-adhesive equipped with the UZIN adhesive tape

Decors

1137 (117) white	0138 (138) light grey	2236 (W 258) light beech	0130 (130) beige	0914 (914) dark beige	0913 (913) light beige	0879 (879) hazel
1069 (121) grey	0146 (146) dark grey	0348 (348) anthracite	0110 (110) black	2175 (33) light oak	2172 (57) beech	

WL 60

Skirting boards for PVC, CV and linoleum floors



Installation recommendations



UZIN
adhesive
tape

- 1 packaging = 1 x 50 m (rolled)
- made of PVC-based polyblend (all ingredients are REACH compliant)

Decors



1137 (117)
white



0138 (138)
light grey



2236 (W 258)
light beech



0130 (130)
beige



0914 (914)
dark beige



0913 (913)
light beige



0879 (879)
hazel



1069 (121)
grey



0146 (146)
dark grey



0348 (348)
anthracite



0110 (110)
black



2175 (33)
light oak



2172 (57)
beech

WL 60 life

Skirting boards for PVC, CV and linoleum floors



Installation recommendations



UZIN
adhesive
tape

TCF
totally
chlorinefree

- 1 packaging = 1 x 50 m (rolled)
- made of elastic chlorine-free PP/TPEbased polyblend
- chlorine-free and plasticizer-free

Decors



1137 (117)
white



0138 (138)
light grey



2236 (W 258)
light beech



0130 (130)
beige



0914 (914)
dark beige



0913 (913)
light beige



0879 (879)
hazel



1069 (121)
grey



0146 (146)
dark grey



0348 (348)
anthracite



0110 (110)
black



2175 (33)
light oak



2172 (57)
beech

WLK 60

Skirting boards for PVC, CV and linoleum floors

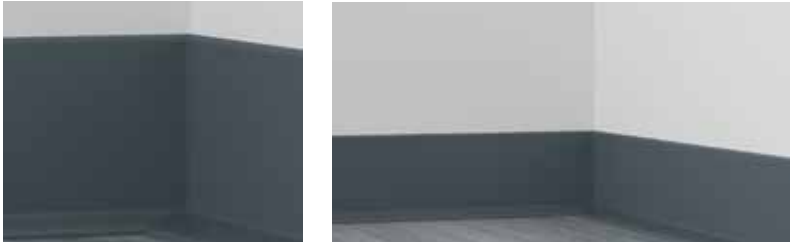

- 1 packaging = 1 x 50 m (rolled)
- made of PVC-based polyblend (all ingredients are REACH compliant)
- self-adhesive equipped with the UZIN adhesive tape

Decors

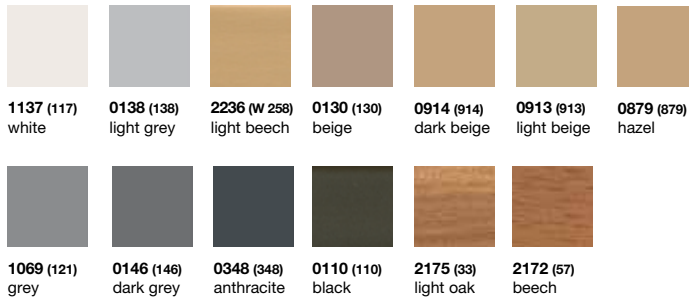

Flexible floor skirtings

WLK 60 life

Skirting boards for PVC, CV and linoleum floors



Installation recommendations



UZIN
adhesive
tape

TCF
totally
chlorinefree

- 1 packaging = 1 x 50 m (rolled)
- made of elastic chlorine-free PP/TPE-based polyblend
- chlorine-free and plasticizer-free
- self-adhesive equipped with the UZIN adhesive tape

Decors



WL 80

Skirting boards for PVC, CV and linoleum floors



- 1 packaging = 1 x 25 m (rolled)
- made of PVC-based polyblend (all ingredients are REACH compliant)

Decors



0130 (130)
beige



0146 (146)
dark grey



0132 (132)
brown



0110 (110)
black

WL 100

Skirting boards for PVC, CV and linoleum floors



- 1 packaging = 1 x 25 m (rolled)
- made of PVC-based polyblend (all ingredients are REACH compliant)

Decors



0130 (130)
beige



0146 (146)
dark grey



0132 (132)
brown



0110 (110)
black

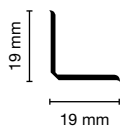

- 1 packaging = 4 x 25 m (rolled)
- made of PVC-based polyblend (all ingredients are REACH compliant)
- self-adhesive coating

Decors



- | | | | | | |
|----------------------------|---------------------------------|----------------------------|--------------------------------|----------------------------|----------------------------|
| 1137 (117)
white | 0138 (138)
light grey | 0130 (130)
beige | 0146 (146)
dark grey | 0132 (132)
brown | 0110 (110)
black |
|----------------------------|---------------------------------|----------------------------|--------------------------------|----------------------------|----------------------------|







Stair profiles and auxiliary profiles

Sturdy and reliable

Reliable protection of high traffic areas

Provide on elegant finish of passages or protect different kinds of floorings on staircases. A large choice of sizes and Decors of universal stair profiles enable reliable and sturdy fit-out of stair, near-stair and wall surfaces. These profiles comply with the REACH regulation and, therefore, do not contain harmful softening agents.

	Product	Dimensions	Page
	TKE 37/28/2,3	H: 28 mm B: 37 mm L: 4,5 m	47
	TKE 40/40/3	H: 40 mm B: 40 mm L: 4,5 m	47
	TKE 25/30/4,5	H: 30 mm B: 25 mm L: 4,5 m	47
	TKE 40/28/5	H: 28 mm B: 40 mm L: 4,5 m	48



Solidcore skirtings

System floor skirtings

Flexible floor skirtings

Stair profiles and auxiliary profiles

Woodem skirting





Kitchen worktop wall joint trims

Tools

Laminate underlays

Aluminium profiles

Racks – Displays

	Product	Dimensions	Page
	TKE 40/40/5	H: 40 mm B: 18 mm L: 5 m	48
	TK 35/40/2	H: 40 mm B: 35 mm L: 4,5 m	48
	TK 35/40/2R	H: 40 mm B: 35 mm L: 4,5 m	49
	TK 35/40/3R	H: 40 mm B: 35 mm L: 4,5 m	49

	Product	Dimensions	Page
	TK 40/25/2R	H: 25 mm B: 40 mm L: 4,5 m	49
	TK 69/40/R	H: 40 mm B: 69 mm L: 4,5 m	50
	Profil najazdowy	H: 2/3 mm B: 41 mm L: 25 m	50
	EL 3,5	H: 32 mm B: 5 mm L: 4 m	51
	HK 15/15, 20/20, 25/25	H: 15/20/25 mm B: 15/20/25 mm L: 5 m	51
	HK 100 Basic	H: 100 mm B: 30 mm L: 2,5 m	52
	EL 8	H: 8 mm B: 31 mm L: 4 m	52
	WL 20/20, 30/30, 40/40	H: 10/15/25/40/50 mm B: 10/15/25/40/50 mm L: 2.75 m	53
	VS 12/12		53
	HK 22/22		53
	TEL 20/TIW 20	H: 22 mm B: 22 mm L: 2,6 m	54
	Stair frame profile TWP45/3	H: 45 mm B: 3 mm L: 2,5 m	55
	Heating pipe cover strip	H: 45 mm B: 107 mm L: 200 m	55

TKE 37/28/2,3

Flexible stair edge nosing

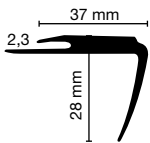

1 package = 10 x 4,50 m

Decors



Using a PVC polymer
(all materials used in the skirtings board comply with REACH regulations)

Installation recommendations

- dull the edge of stairs
- do not place adhesive on a vertical surface of the stair



TKE 40/40/3

Flexible stair edge nosing

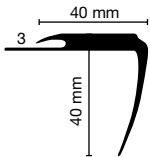

1 package = 10 x 4,50 m

Decors



Using a PVC polymer
(all materials used in the skirtings board comply with REACH regulations)

Installation recommendations

- dull the edge of stairs
- do not place adhesive on a vertical surface of the stair



TKE 25/30/4,5

Flexible stair edge nosing

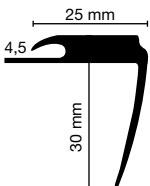

1 package = 10 x 4,50 m

Decors



Using a PVC polymer
(all materials used in the skirtings board comply with REACH regulations)

Installation recommendations

- dull the edge of stairs
- do not place adhesive on a vertical surface of the stair



TKE 40/28/5

Flexible stair edge nosing

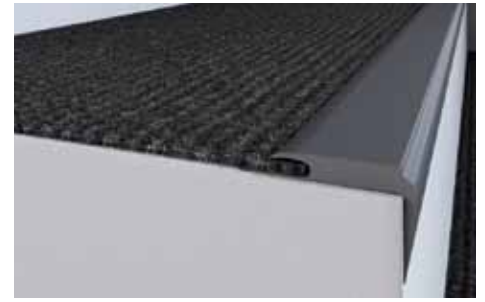
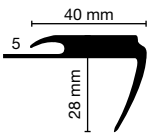

1 package = 10 x 4,50 m

Decors



Using a PVC polymer
(all materials used in the skirtings board comply with REACH regulations)

Installation recommendations

- dull the edge of stairs
- do not place adhesive on a vertical surface

TKE 40/40/5

Flexible stair edge nosing

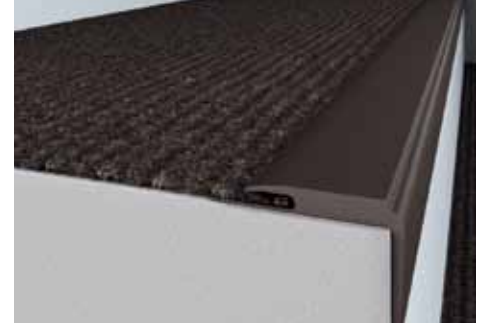
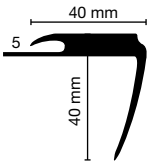

1 package = 10 x 4,50 m

Decors



Using a PVC polymer
(all materials used in the skirtings board comply with REACH regulations)

Installation recommendations

- dull the edge of stairs
- do not place adhesive on a vertical surface

TK 35/40/2

Flexible stair edge nosing

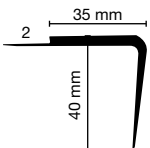

1 package = 10 x 4,50 m

Decors



Using a PVC polymer
(all materials used in the skirtings board comply with REACH regulations)

Installation recommendations

- dull the edge of stairs
- do not place adhesive on a vertical surface

TK 35/40/2 R

Flexible stair edge nosing

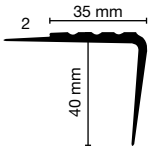

1 package = 10 x 4,50 m



Using a PVC polymer
(all materials used in the skirtings board comply with REACH regulations)

- profiled vertical surface Installation

Installation recommendations

- dull the edge of stairs
- do not place adhesive on a vertical surface

Decors



TK 35/40/3 R

Flexible stair edge nosing

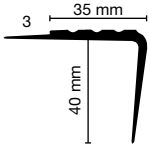

1 package = 10 x 4,50 m



Using a PVC polymer
(all materials used in the skirtings board comply with REACH regulations)

- profiled vertical surface Installation

Installation recommendations

- dull the edge of stairs
- do not place adhesive on a vertical surface

Decors



TK 40/25/2 R

Flexible stair edge nosing

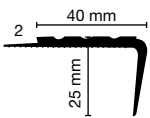

1 package = 10 x 4,50 m



Using a PVC polymer
(all materials used in the skirtings board comply with REACH regulations)

- profiled vertical surface Installation

Installation recommendations

- dull the edge of stairs
- do not place adhesive on a vertical surface

Decors



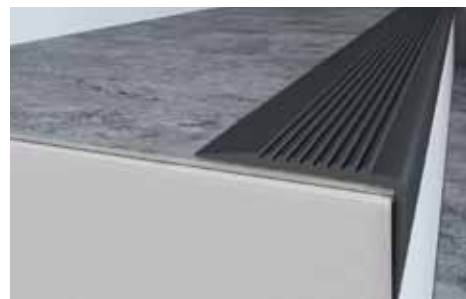
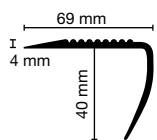

1 package = 10 x 4,50 m

Using a PVC polymer
(all materials used in the skirtings board comply with REACH regulations)

- profiled vertical surface Installation

Installation recommendations

- dull the edge of stairs
- do not place adhesive on a vertical surface



Decors



0138 (138)
light grey

0130 (130)
beige

0146 (146)
dark grey

0132 (132)
brown

0110 (110)
black

Approach profile

for floors over 3 mm thick

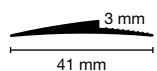

1 package = 4 x 25 m

- PVC polymer-based skirtings board (all components compliant with REACH)
- for levelling floors
- it is particularly suited for creating smooth transitions in case of different levels

Decors



1063 (W199)
silver

1083 (W 196)
stainless
steel

1010 (W 075)
cappuccino

1091 (W 072)
chocolate
brown

0110 (110)
black

EL 3,5

Finishing trim

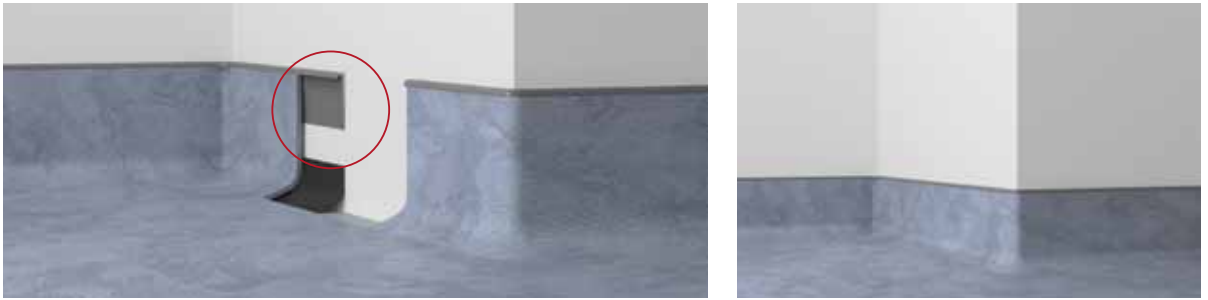
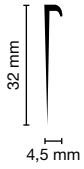

1 package = 25 x 4,00 m

- PVC-based polymer (all materials used in the skirtings board comply with REACH regulations)
- finishing trim for floorings curling on walls and flooring drywalls

Decors

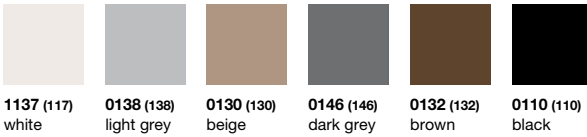

1137 (117) white
0138 (138) light grey
0130 (130) beige
0146 (146) dark grey
0132 (132) brown
0110 (110) black

Stair profiles and auxiliary profiles

HK 15/15, 20/20, 25/25

Cove former

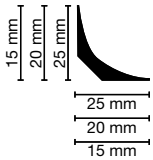

HK 15/15: 1 package = 20 x 5 m On special order on Rolls 25 m
 HK 20/20: 1 package = 20 x 5 m
 HK 25/25: 1 package = 20 x 5 m

- PVC-based polymer (all materials used in the skirtings board comply with REACH regulations)
- for preparation of precise connections between walls and floors in case of floorings curling on walls

Decor



0110 (110) black

HK 100

Finishing trim for curling floorings

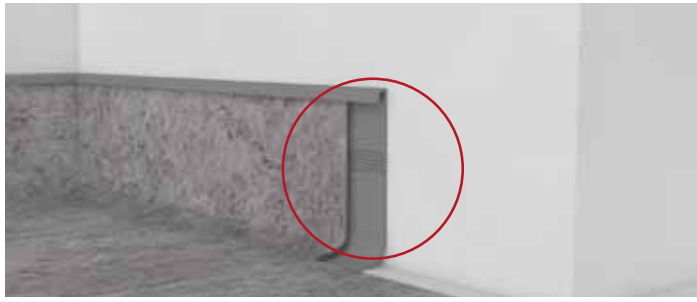
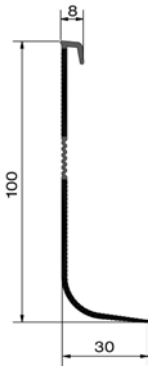

1 package = 40 x 2,50 m



- PVC-based polymer (all materials used in the skirtings board comply with REACH regulations)
- for preparation of precise connections between walls and floors in case of floorings curling on walls

Product available on request.

Decors

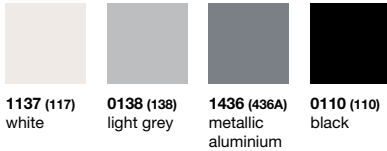

EL 8

Finishing trim

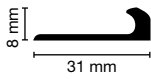

1 package = 25 x 4,00 m



- finishing trim of floorings on open spaces
- using a PVC polymer (all materials used in the skirtings board comply with REACH regulations)
- for thin floorings, also use the EL 3.5 profile

Decors

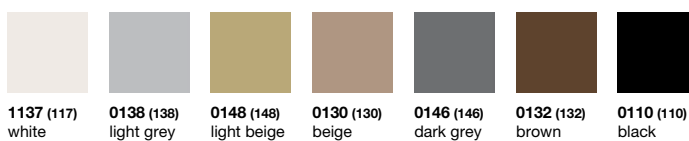

WL 20/20, 30/30, 40/40

Corner skirtings board

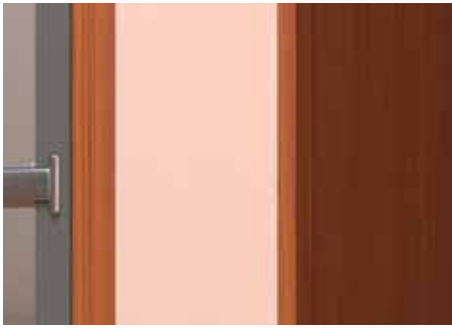
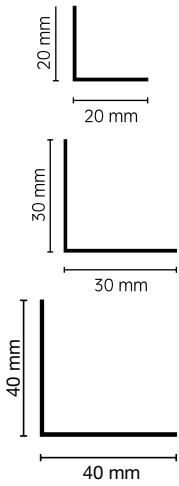

1 package = 20 x 2,5 m

- made of flexible plastic
- printable on both sides
- also available in the following sizes (on request):
10 x 10, 15 x 15, 10 x 10, 15 x 15, 25 x 25, 40 x 40, 50 x 50 mm

Decors



- | | | | | | | | | |
|----------------------------|-----------------------------------|--|---------------------------------|------------------------------|------------------------------|--------------------------------|----------------------------|------------------------------|
| 1137 (117)
white | 2186 (41)
grey ash tree | 2208 (655N)
kirschbaum antik | 2174 (659N)
light oak | 2171 (30)
dark oak | 2079 (660 N)
beech | 2170 (26)
kirschbaum | 2073 (22)
walnut | 2215 (54)
mahagoni |
|----------------------------|-----------------------------------|--|---------------------------------|------------------------------|------------------------------|--------------------------------|----------------------------|------------------------------|



VS 12/12

Quadrant skirtings board

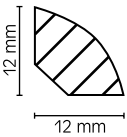

1 package = 20 x 2,50 m

- made of flexible plastic
- masking skirtings board, cover profile for securing irregularities, it is also possible to combine it with a plinth skirtings board



Decors



- | | | | | | | |
|---------------------|-----------------------|---------------------|-----------------------|---------------------|---------------------|-----------------------|
| 117
white | 660 N
beech | 659 N
oak | 30
dark oak | 26
cherry | 22
walnut | 54
mahogany |
|---------------------|-----------------------|---------------------|-----------------------|---------------------|---------------------|-----------------------|

HK 22/22

Concave skirting board

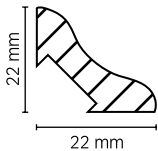

1 package = 20 x 2,50 m

- made of flexible plastic
- masking skirtings board, cover profile for securing irregularities, it is also possible to combine it with a plinth skirtings board



Decors



- | | | | | | | |
|---------------------|-----------------------|---------------------|-----------------------|---------------------|---------------------|-----------------------|
| 117
white | 660 N
beech | 659 N
oak | 30
dark oak | 26
cherry | 22
walnut | 54
mahogany |
|---------------------|-----------------------|---------------------|-----------------------|---------------------|---------------------|-----------------------|

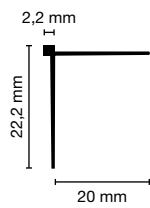

1 package = 20 x 2,60 m

Using an ABS-based polymer,
for easy and smooth finish of the external
angular profile during wallpapering

Decors

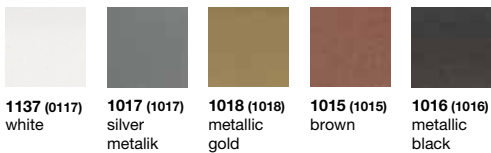

1 package = 20 x 2,60 m

Using an ABS-based polymer,
for easy and smooth finish of the internal
angular profile during wallpapering

Decor



1137 (117)
white

Stair frame profile TWP45/3

Side edge for the stairs



- 1 packaging = 20 x 2,5 m
- made of AS-based polyblend, for perfect covering of the stair frame

Decors



1137 (0117)
white

Heating pipe cover strip

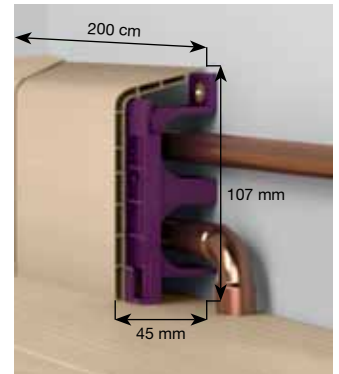

- 1 packaging = 10 x 2 m
- foil-coated rigid plastic
- made of double-walled plastic
- soft plastic lips allow the installation also on uneven walls
- pipe clips serve for stabilizing the heat pipes and fixing the board)
- matching accessories for perfect installation
- rough mitre saw (accessories cover the cut)

Accessories



Inside corner 90°
packaging = 5 x 1 pcs, printed self-service packaging



Outside corner 90°
packaging = 5 x 1 pcs, printed self-service packaging

Fixing



Pipe clip
packaging = 10 x 5 pcs, self-service packaged

Decors



white maple light beech oak beech



Endcaps links
packaging = 5 x 1 pcs, printed self-service packaging



Endcaps rechts
packaging = 5 x 1 pcs, self-service packaging



Connector
packaging = 5 x 1 pcs, bedruckt SB-verpackt







Wooden skirting

High-quality wooden skirting from Döllken Weimar.



Clear shapes – beautiful decor – multiple applications

Döllken Weimar also applies its many years of experience and expertise to the natural material timber. High-quality materials are used to create skirting boards that combine aesthetics, quality and durability. The PEFC und FSC certificates document the environmental credentials of raw materials used, and the various shape and decor options meet every aesthetic requirement. We have products available that extend beyond our standard range and would be happy to advise you.

	Article	Dimensions	Accessories	Installation recommendation	Page
	MDF skirting board Classic 40	H: 40 mm B: 22 mm L: 2,5 m	<ul style="list-style-type: none"> • Internal corners 90° • External corners 90° • End caps left/right 	• ClipStar metal	58
	MDF skirting board Modern 60	H: 60 mm B: 15 mm L: 2,5 m	<ul style="list-style-type: none"> • Internal corners 90° • External corners 90° • End caps left/right 	• ClipStar metal	58
	MDF skirting board Cubica 50	H: 50 mm B: 14 mm L: 2,5 m		• ClipStar metal	59
	MDF quarter round 12	H: 12 mm B: 12 mm L: 2,5 m		• Döllken skirting pins	59
	MDF concave skirting 22	H: 22 mm B: 22 mm L: 2,5 m		• Döllken skirting pins	60
	MDF corner protection 22	H: 22 mm B: 22 mm L: 2,5 m		• Döllken skirting pins	60



Solidcore skirtings

System floor skirtings

Flexible floor skirtings

Stair profiles and auxiliary profiles

Woodem skirting

	Article	Dimensions	Accessories	Installation recommendation	Page
	Veneer skirting Classic 40	H: 40 mm B: 22 mm L: 2,5 m	<ul style="list-style-type: none"> • Internal corners 90° • External corners 90° • End caps left/right 	• ClipStar metal	61
	Veneer skirting Classic 60	H: 60 mm B: 22 mm L: 2,5 m	<ul style="list-style-type: none"> • Internal corners 90° • External corners 90° • End caps left/right 	• ClipStar metal	61
	Veneer skirting Modern 40	H: 38 mm B: 19 mm L: 2,5 m		• ClipStar metal	62
	Veneer skirting Modern 60	H: 60 mm B: 15 mm L: 2,5 m	<ul style="list-style-type: none"> • Internal corners 90° • External corners 90° • End caps left/right 	• ClipStar metal	62
	Veneer skirting Cubica 60	H: 60 mm B: 16 mm L: 2,5 m		• ClipStar metal	63
	Veneer concave skirting 24	H: 24 mm B: 24 mm L: 2,5 m		• Döllken skirting pins	63
	Veneer quarter round 14	H: 14 mm B: 14 mm L: 2,5 m		• Döllken skirting pins	64
	White & black Style	H: 60/70/100/ 120 mm B: 18 mm L: 2,5 m		• ClipStar metal	64
	White & black Cubica	H: 40/60/70/ 100 mm B: 18 mm L: 2,5 m		• ClipStar metal	65
	MDF skirting X-creative	H: 58 mm B: 17 mm L: 2,5 m		• ClipStar metal	65

Kitchen worktop wall joint trims

Tools

Laminate underlays

Aluminium profiles

Racks – Displays

MDF skirting Classic 40

ideal for laminate

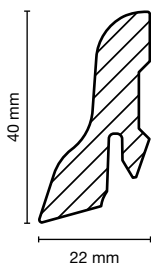

Installation recommendation



sales unit = 10 x 2.5 m

- foiled-wrapped MDF skirting board
- particularly suitable for low wall finishes for parquet and laminate flooring
- cutting and mitre cuts with a fine-toothed saw possible
- simple and perfect installation thanks to special mounting clips
- with cable duct for telephone or computer cable

Accessories (1 sales unit = 10 pieces)



Internal corners 90°
self-service (SS)
= 5 x 1 pieces



External corners 90°
self-service (SS)
= 5 x 1 pieces



End caps left/right
self-service (SS)
= 5 x 1 pair

Decors

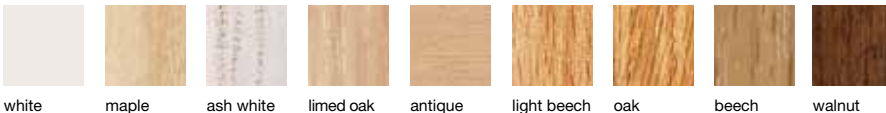

white maple ash white limed oak antique light beech oak beech walnut

MDF skirting Modern 60

ideal for laminate

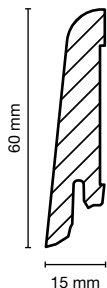

Installation recommendation



1 sales unit = 10 x 2.5 m

- foil-wrapped MDF skirting
- simple and perfect installation thanks to special mounting clips
- cutting, cut-to-length sections and mitre cuts with a fine-toothed saw possible
- durability due to high quality laminate, available in all popular Decors and decors

Accessories (1 sales unit = 10 pieces)



Internal corners 90°
self-service (SS)
= 5 x 1 pieces



External corners 90°
self-service (SS)
= 5 x 1 pieces



End caps left/right
self-service (SS)
= 5 x 1 pair

Decors

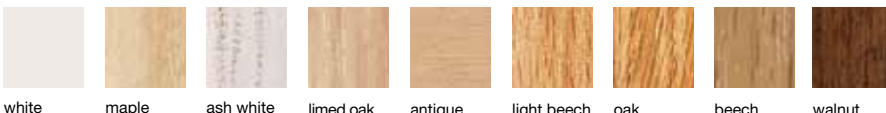

white maple ash white limed oak antique light beech oak beech walnut

MDF skirting Cubica 50

ideal for laminate

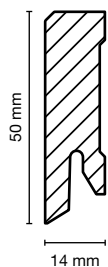

Installation recommendation



ClipStar
metal

1 sales unit = 10 x 2.5 m

- foil-wrapped laminate skirting
- simple and perfect installation thanks to special mounting clips
- cutting, cut-to-length sections and mitre cuts with a fine-toothed saw possible
- durability due to high quality laminate, available in all popular Decors and decors

Decors



white maple ash white limed oak antique light beech oak beech walnut

MDF quarter round 12

ideal for laminate

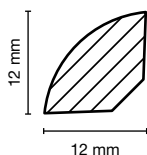

Installation recommendation



Döllken
skirting pins

1 sales unit = 25 x 2.5 m

- foil-wrapped MDF skirting
- cutting and mitre cuts with a fine-toothed saw possible
- installation possible using either screws, nails or adhesive
- flexible to allow adjustment for slight curvatures in the wall
- many applications with consistent decors and Decors
- white skirting can be subsequently painted

Decors



white maple ash white light beech oak beech walnut black

MDF concave skirting 22

ideal for laminate

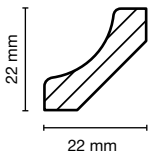

Installation recommendation



Döllken
skirting pins

• 1 sales unit = 30 x 2.5 m

- foil-wrapped MDF skirting
- cutting and mitre cuts with a fine-toothed saw possible
- installation possible using either screws, nails or adhesive
- flexible to allow adjustment for slight curvatures in the wall
- many applications with consistent decors and Decors
- white skirting can be subsequently painted

Decors



white



maple



ash white



light beech



oak



beech



walnut



black

MDF corner protection 22

to protect edges

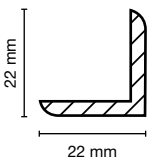

Installation recommendation



Döllken
skirting pins

1 sales unit = 30 x 2.5 m

- foil-wrapped MDF skirting
- can be used as external corner
- with structured outer side
- cutting with a fine-toothed saw possible

Decors



white



maple



ash white



light beech



oak



beech



walnut



black

Veneer skirting Classic 40

Solid wood – natural and low maintenance

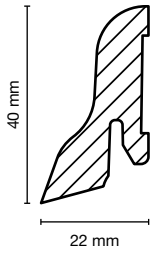

Installation recommendation



ClipStar
metal

1 sales unit = 10 x 2.5 m

- veneered solid wood skirting
- particularly suitable for low wall finishes for fine parquet flooring
- cutting and mitre cuts with a fine-toothed saw possible
- simple and perfect installation thanks to special mounting clips
- with cable duct for telephone or computer cable

Accessories (1 sales unit = 10 pieces)



Internal corners
90°
self-service (SS)
= 5 x 1 pieces



External corners
90°
self-service (SS)
= 5 x 1 pieces



End caps left/right
self-service (SS)
= 5 x 1 pair

Decors



white hevea maple limed oak antique oak beech walnut

Veneer skirting Classic 60

Solid wood – natural and low maintenance

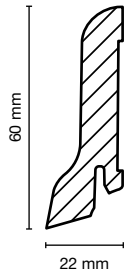

Installation recommendation



ClipStar
metal

1 sales unit = 10 x 2.5 m

- veneered solid wood skirting
- attachment possible with screws, nails and adhesive
- cutting and mitre cuts with a fine-toothed saw possible
- simple and perfect installation thanks to special mounting clips
- with cable duct for telephone or computer cable

Accessories (1 sales unit = 10 pieces)



Internal corners
90°
self-service (SS)
= 5 x 1 pieces



External corners
90°
self-service (SS)
= 5 x 1 pieces



End caps left/right
self-service (SS)
= 5 x 1 pair

Decors



white hevea maple limed oak antique oak beech walnut

Veneer skirting Modern 40

Solid wood – natural and low maintenance

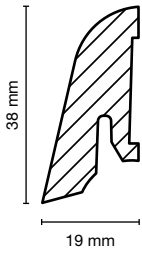

Installation recommendation



ClipStar
metal

1 sales unit = 10 x 2.5 m

- veneered solid wood skirting
- particularly suitable for low wall finishes for fine parquet flooring
- cutting and mitre cuts with a fine-toothed saw possible
- simple and perfect installation thanks to special mounting clips
- with cable duct for telephone or computer cable

Decors



white

hevea

maple

limed oak

antique

oak

beech

walnut

Veneer skirting Modern 60

Solid wood – natural and low maintenance

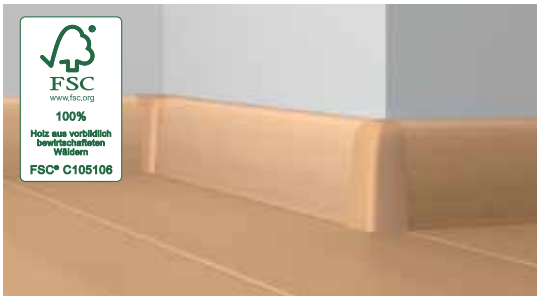
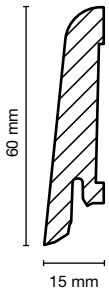

Installation recommendation



ClipStar
metal

1 sales unit = 10 x 2.5 m

- veneered solid wood skirting
- cutting and mitre cuts with a fine-toothed saw possible
- simple and perfect installation thanks to special mounting clips
- with cable duct for telephone or computer cable

Accessories (1 sales unit = 10 pieces)



**Internal corners
90°**
self-service (SS)
= 5 x 1 pieces



**External corners
90°**
self-service (SS)
= 5 x 1 pieces



End caps left/right
self-service (SS)
= 5 x 1 pair

Decors



white

hevea

maple

limed oak

antique

oak

beech

walnut

Veneer skirting Cubica 60

Solid wood – natural and low maintenance

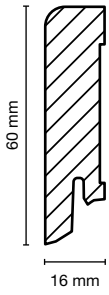

Installation recommendation



ClipStar
metal

1 sales unit = 10 x 2.5 m

- veneered solid wood skirting
- cutting and mitre cuts with a fine-toothed saw possible
- simple and perfect installation thanks to special mounting clips
- with cable duct for telephone or computer cable

Decors



white hevea maple limed oak antique oak beech walnut

Veneer concave cover strip 24

Solid wood – natural and low maintenance

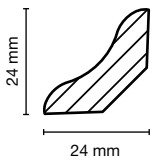

Installation recommendation



Döllken
skirting pins

1 sales unit = 10 x 2.5 m

- veneered solid wood skirting
- for low wall finishes
- cutting and mitre cuts with a fine-toothed saw possible

Decors



white hevea maple limed oak antique oak beech walnut

Veneer quarter round 14

Solid wood – natural and low maintenance

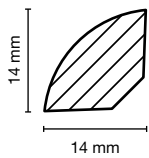

Installation recommendation



Döllken
skirting pins

1 sales unit = 10 x 2.5 m

- veneered solid wood skirting
- cutting and mitre cuts with a fine-toothed saw possible
- installation possible using either screws, nails or adhesive
- many applications with consistent decors and Decors

Decors



white hevea maple limed oak antique oak beech walnut

White & black Style

strong contrasts

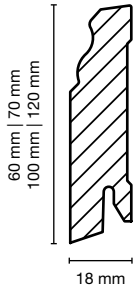

Installation recommendation



ClipStar
metal

1 sales unit = 5 x 2.5 m

- MDF profiles, foil-wrapped, can be painted
- cutting and mitre cuts with a fine-toothed saw possible
- simple and perfect installation thanks to special mounting clips

Decors



matt white

White & black Cubica

strong contrasts

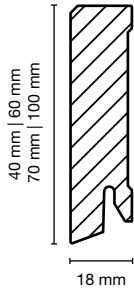

Installation recommendation



ClipStar
metal

1 sales unit = 5 x 2.5 m

- MDF profiles, foil-wrapped, can be painted (only matt white)
- cutting and mitre cuts with a fine-toothed saw possible
- simple and perfect installation thanks to special mounting clips

Decors



white high gloss white stainless steel black

MDF skirting X-creative

Individual decor

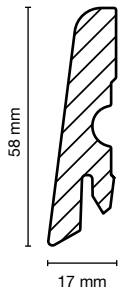

Installation recommendation



ClipStar
metal

• 1 sales unit = 1 x 2.5 m

- MDF skirting
- simple and perfect installation thanks to special mounting clips
- modern, colourful decor for a distinctive look
- cutting and mitre cuts with a fine-toothed saw possible

**Why not create skirting with your own individual decor.
Just get in touch!**

Example decor



animals



grassland



bottle corks



shingle



fanasy



floral



zebra print



Africa print



coffee beans

Kitchen worktop wall joint trims



Design and functionality



Professional worktop finishes

Professional finishes of kitchen worktops, perfectly covering expansion joints and gaps. Easy and, at the same time, modern, with harmonious shape, and of the highest quality.

Easy to install, they will protect every gap from water penetration, at the same time protecting the worktop. Aesthetics and practicality combine into one cohesive whole.

	Product	Content	Page
	Hi4 wall joint trim		68
	Design wall joint trim		69



Solidcore skirtings

System
floor
skirtings

Flexible
floor
skirtings

Stair profiles and
auxiliary profiles

Woodem skirting

**Kitchen worktop
wall joint trims**

Tools

Laminate
underlays

Aluminium profiles

Racks –
Displays



1 package = 10 x 2,50 m

- plastic skirtings board covered with aluminium with soft edges
- self-adhesive
- for completely covering gaps, both horizontal and vertical
- resistant to abrasion and detergents

Equipment:

1 package = 10 sets

* sample book available onrequest

** 4 & 5 running-metre lengths available on request

A set contains:

- 4 x 90° internal angular profile
- 2 x 135° internal angular profile
- 2 x 90° external angular profile
- 2 pairs of finishing trims

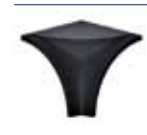

Internal angular



135° internal angular profile



External angular

Decors



white

silver

aluminium

black



Right finishing trim



Left finishing trim



Design wall joint trim

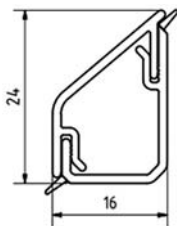

1 package = 6 x 3,00m
or
1 package = 6 x 0,60m

- plastic skirtings board for cosmetic worktop finishes
- finished with colourless, soft edges that perfectly mask all gaps
- self-adhesive strips on both sides of the assembly profile facilitate the installation of the skirtings board
- wide range of Decors
- varied choice of accessories enabling perfect finishes

Equipment

1 package = 5 sets

A set contains:

- 1 x 90° internal angular profile
- 1 x 90° external angular profile
- 1 x right finishing trim
- 1 x left finishing trim

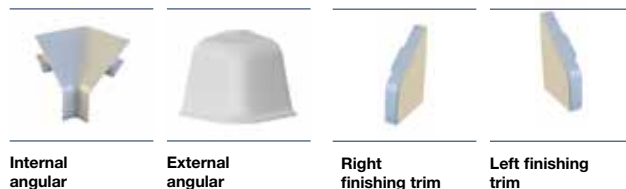

Dimensions:

Height: 24 mm
Width: 16 mm
Length: 3,00 m / 60 cm

Decors

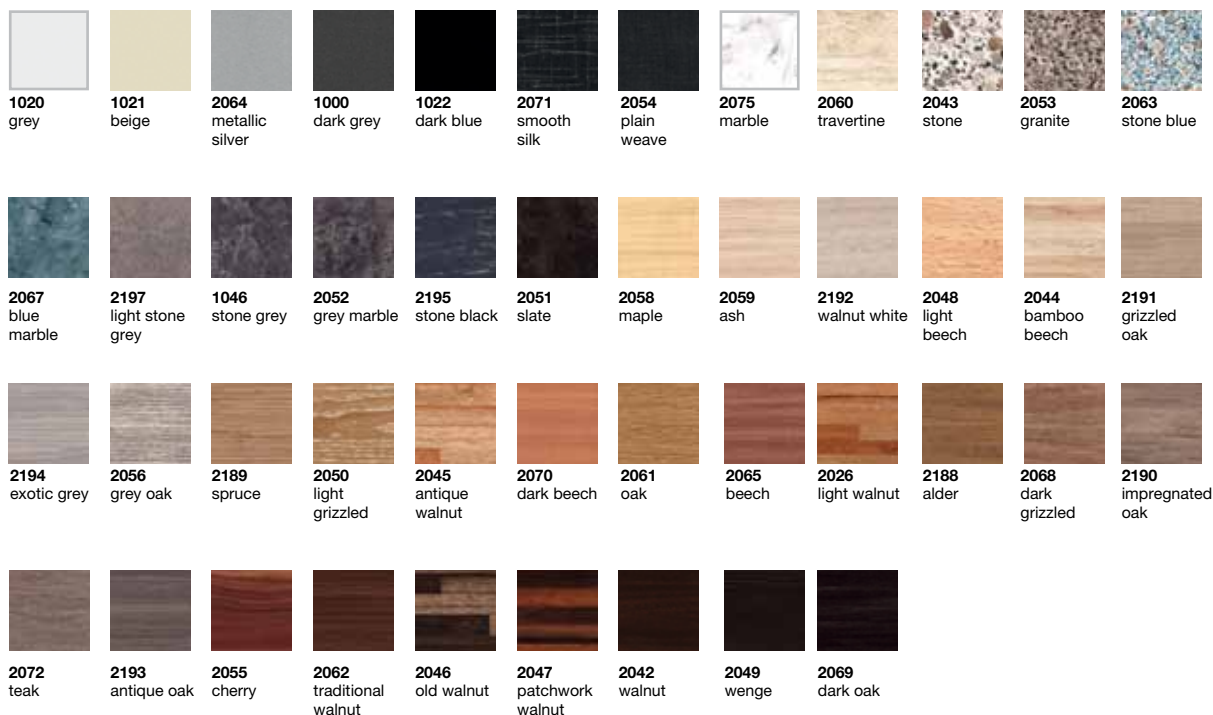

Decors of accessories

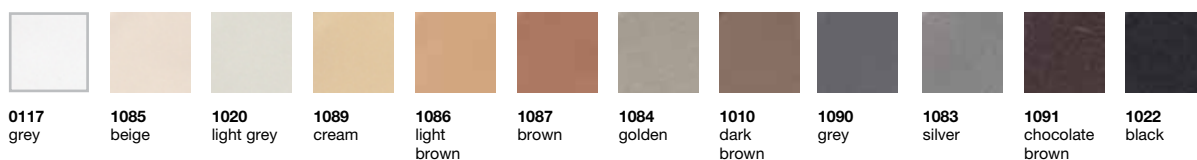



Tools

Quick and easy
assembly and installation

Easily overcome difficult challenges

A quick work pace that guarantees workmanship quality and reliable installation of mounted floor skirtings are standard requirements for artisans. In order to meet this, Döllken offers a wide range of reliable tools. Furthermore, quick, clean and reliable fixing is provided by our efficient hot-melt adhesive system.

	Product	Content	Page
	Mitre tool Type 1001	<ul style="list-style-type: none">• edge cutter type 1001• skirting strip scissors• clamp for luxury floor strips• cutter casing• measuring templates• folding ruler• user manual	72
	Replaceable clamp for Cubu XL	<ul style="list-style-type: none">• user manual	72



Solidcore skirtings

System floor skirtings

Flexible floor skirtings

Stair profiles and auxiliary profiles

Woodem skirting

Kitchen worktop wall joint trims

Tools

Laminate underlays

Aluminium profiles

Racks – Displays

	Product	Content	Page
	Cutter		72
	Hot-melt adhesive system	<ul style="list-style-type: none"> • hot-melt adhesive gun HPK 220 included casing cranked nozzle and 4.5-meter cable • hot-melt adhesive HKS 18/300 	74
	Dry adhesive tape		74
	Scissors		74
	Floorboard		74

Mitre tool Type 1001

For all Döllken HDF-core skirtings boards

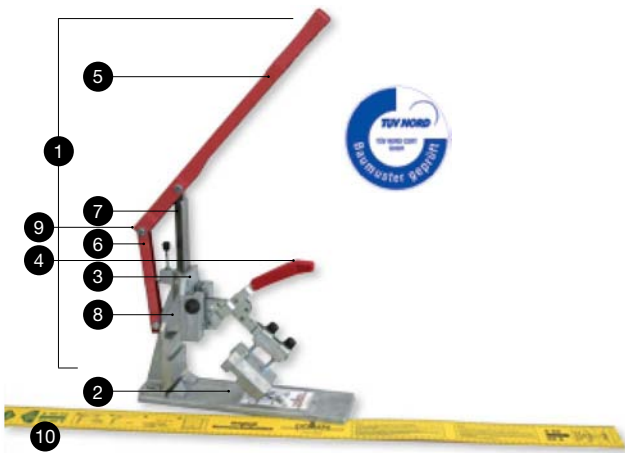

	Döllken Stanzen Bezeichnung	Product-Nr.
1	edge cutter type 1001	5105431
2	base plate for the cutter	5106890
3	double slot plate for cutter type 1001	5106892
4	vertical toggle clamp for universal cutter type 1001	5106893
5+6	grip with tongue	5106894
7	spare blade	5106896
8	blade guiding block	5106885
9	spare tongue	5106897
10	measuring templates	
11	cutter clamp for design floors	5105434
12	cutter casing (empty)	



All skirtings boards prepared for processing using the mitre tool are marked with an icon (shown).

- perfect for cutting all skirtings boards with cores
- easy to determine a cutting point
- enables cutting DSL 60 (external angle) skirtings boards using special Mitre tool overlays

The Mitre tool is also available as a set in a handy carry case.

The set includes:

- the case
- Mitre tool, Type 1001
- scissors for skirtings
- overlays for cutting skirtings boards for designed floors
- measurement template
- ruler

The aforementioned articles are also available separately.

* Cubu XL suitable for die cutting only with clamping lever XL.

* option to purchase spare parts



Replaceable clamp

For the mitre tool, Type 1001, for Cubu flex XL skirtings boards



For cutting Cubu flex XL skirtings boards



All skirtings boards prepared for installation using clamps are marked with an icon (shown).

Flooring strip cutter



Special cutter for exact and safe flooring strip cutting. Perfect for cutting modern PVC, CV and lino floorings. Strips with the width of 51 mm are placed in the D60 and C60 hard-core skirtings boards.



All skirtings to be cut using the strip cutter have this icon.



Cutter casing

Compact and well-organized!
The cutter is available also in
a complete casing set.

Hot-melt adhesive system



We highly recommend the complete system for professional bonding of thick skirtings with a core and system skirtings boards (please read the bonding manual) that includes:

- a HKP 220 hot-melt adhesive gun with a 4.5 m cable in a practical case
- HKS 18/300 hot-melt adhesive for application using the HKP 220 1VE gun:
 - 5 bags 2 kg each = 10 kg
 - quantity in the bucket:
 - colourless: 69 pcs. of adhesive
 - orange: 67 pcs. of adhesive



All skirtings boards prepared for installation using hot-melt adhesive are marked with an icon (shown)

Dry adhesive tape



In order to install various types of skirtings (please read the skirting installation manual), we also recommend using the UZIN installation tape (Toptac 35) available from Döllken.

Installation products from this manufacturer are perfectly suited to Döllken skirtings. Their use facilitates a secure, reliable and professional installation.



All skirtings boards prepared for installation using UZIN installation tapes are marked with an icon (shown).

Scissors for skirtings

For all Döllken skirtings



For detailed notching of skirtings boards and plastic profiles.



All skirtings boards prepared for installation using scissors are marked with an icon (shown).

Floorboard



Floorboard – perfect for floor laying and tiling as well as pointing and painting works.

FLOORBOARD, the unbreakable knee roller is a must for every professional who performs their work while kneeling. Even after hours is a fatigue-free work possible.

Why you need a floorboard:

- it protects the knees and the back
- it has multiple applications and optimum mobility
- it has a highly stable construction

Technical data: 57 x 33 x 9 cm (L x B x H)

Dimensions:

Load capacity: up to 150 kg

Weight: approx. 4 kg

Additional application possibilities:

Container holder: 30 x 40 cm (length x width) bulge for mixing bucket with a diameter up to 31.5 cm



Please send the repair tools to:
Döllken-Weimar GmbH,
Industriestraße 1, 59199 Bönen





Laminate underlays

Perfect utility



Perfect utility

Perfect acoustic insulation against unwanted sounds in rooms below, and reduction of noise when walking on our floorings. They perfectly level all surface irregularities and due to their properties, they perfectly meet the requirements of thermal insulation, which protects the room from losing heat. Underlay is recommended for laminated wooden floorboards and multi-layer wooden floor elements. Döllken floorings are also recommended for use with underfloor heating. Our floorings prevent fungi and moulds from expanding, and, at the same time, form a solid barrier against them, which has been confirmed by fungistatic tests conducted using the US EPA Pesticide Assessment Guidelines Subdivision method

	Article	Dimensions	Accessories	Installation recommendation	Page
	THERMO roll 1,6 mm	h: 1,1 m t: 1,6 mm l: 15 m			78
	THERMO roll 2 mm	h: 1,1 m t: 2 mm l: 15 m			78
	FLOOR base 2 mm	h: 0,5 m t: 2 mm l: 1,2 m			78
	THERMO base 2,5 mm	h: 1,1 m t: 2,5 mm l: 15 m			79



Solidcore skirtings

System floor skirtings

Flexible floor skirtings

Stair profiles and auxiliary profiles

Woodem skirting







Kitchen worktop wall joint trims

Tools

Laminate underlays

Aluminium profiles

Racks – Displays

	Article	Dimensions	Accessories	Installation recommendation	Page
	FLOOR base 3 mm	h: 0,5 m t: 3 mm l: 1,2 m			79
	FLOOR base 5 mm	h: 0,5 m t: 5 mm l: 1,2 m			79
	PERFECT MAT 1,5 mm	h: 0,5 m t: 1,5 mm l: 0,8 m			80
	EXPRESS mat 3 mm	h: 1 m t: 3 mm l: 12 m			80
	EXPRESS mat 5 mm	h: 1 m t: 5 mm l: 7 m			80
	ALU base	h: 0,5 m t: 2,2 mm l: 1 m			81
	ALU roll	h: 1,1 m t: 2 mm l: 15 m			81

THERMO roll 1,6 mm

Roll

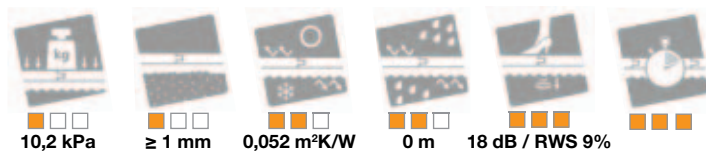

Length – 15 m
 Width – 1,1 m
 Commercial packaging – 16,5 m²
 package – 6 rolls (99 m²)
 Palette = 792 m² (48 rolls)

Recommended for floor heating.

THERMO roll 2 mm

Roll

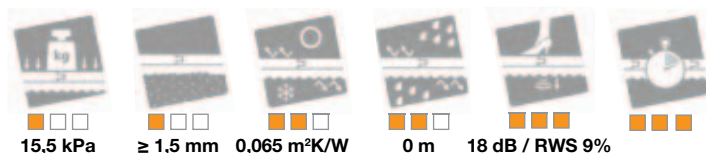

Length – 15 m
 Width – 1,1 m
 Commercial packaging – 16,5 m²
 package – 6 rolls (99 m²)
 Palette = 594 m² (36 rolls)

Recommended for floor heating.

FLOOR base 2 mm

Board

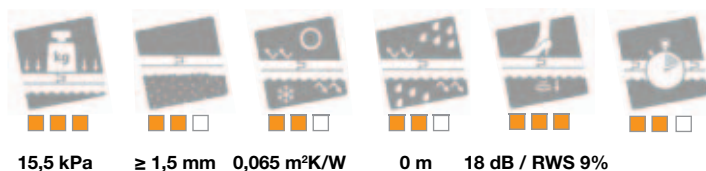

Length – 1,2 m
 Width – 0,5 m
 Commercial packaging – 6 m²
 package – 6 m²
 Bulk package – 90 m²
 Palette = 900 m

THERMO base 2,5 mm

Board

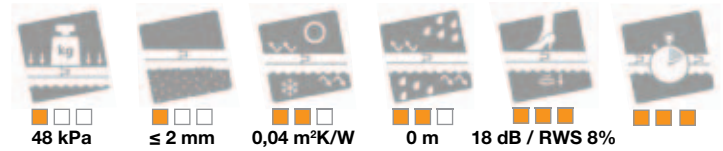
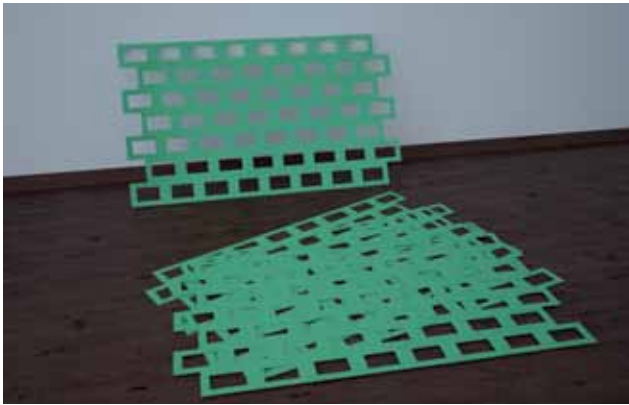

Length – 1 m
 Width – 0,5 m
 Commercial packaging – 6 m²
 package – 6 m²
 Bulk package – 108 m²
 Palette = 864 m²

Recommended for floor heating.

FLOOR base 3 mm

Board

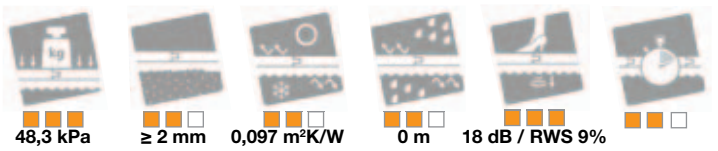

Length – 1,2 m
 Width – 0,5 m
 Commercial packaging – 6 m²
 package – 6 m²
 Bulk package – 72 m²
 Palette = 720 m²

FLOOR base 5 mm

Board

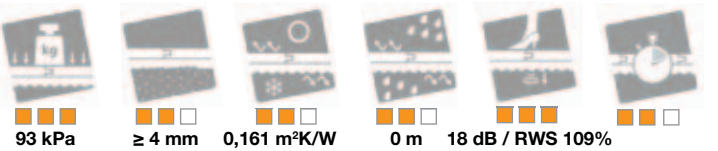

Length – 1,2 m
 Width – 0,5 m
 Commercial packaging – 6 m²
 package – 6 m²
 Bulk package – 48 m²
 Palette = 480 m²

PERFECT MAT 1,5 mm

Board for LVT flooring

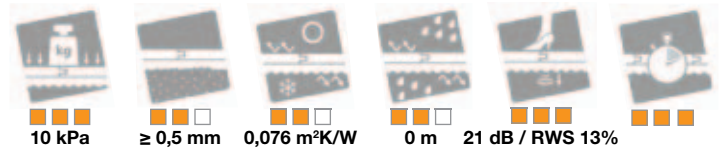

Length – 0,8 m
Width – 0,5 m
Ilość płyt – 15 pcs.
Board's dimension – 80 cm × 50 cm
Bulk package – 6 m²
Karton – 24 m²
Palette = 24 kartony

EXPRESS mat 3 mm

Fold

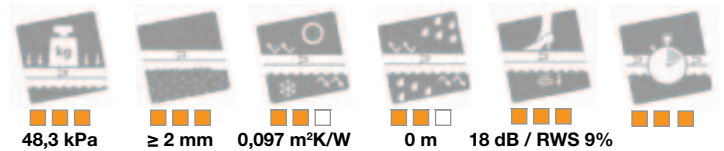

Length – 12 m
Width – 1 m
Commercial packaging – 12 m²
package – 12 m²
Bulk package – 96 m²
Palette = 768 m²

EXPRESS mat 5 mm

Fold

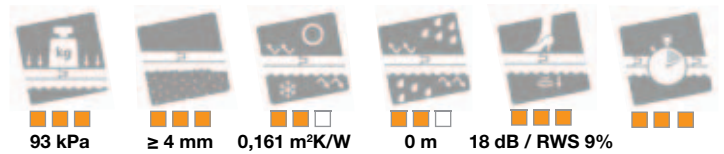

Length – 7 m
Width – 1 m
Commercial packaging – 7 m²
package – 7 m²
Bulk package – 56 m²
Palette = 448 m²

ALU base 2,2 mm

Board

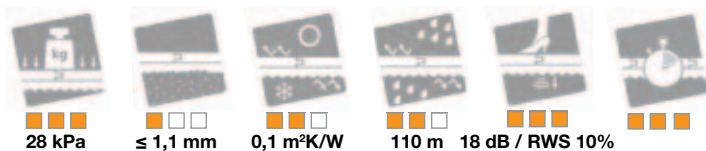
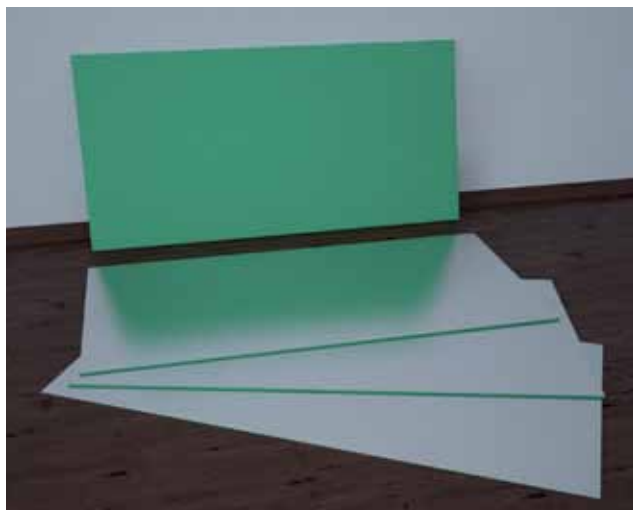

28 kPa $\leq 1,1$ mm 0,1 m²K/W 110 m 18 dB / RWS 10%

Length – 1 m
Width – 0,5 m
Commercial packaging – 10 m²
package – 10 m²
Bulk package – 120 m²
Palette = 960 m²

ALU roll 2 mm

Roll

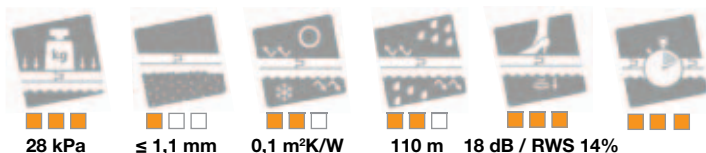
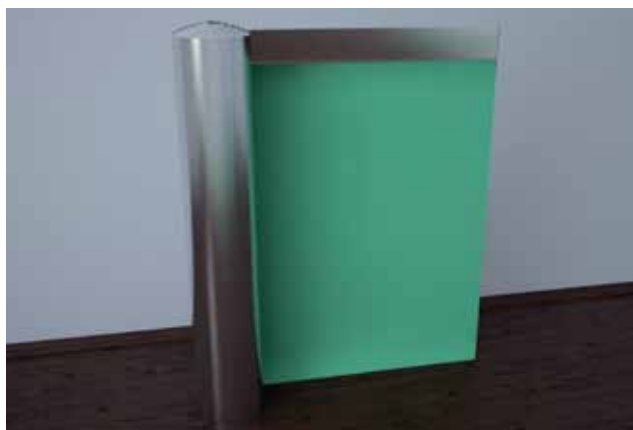

28 kPa $\leq 1,1$ mm 0,1 m²K/W 110 m 18 dB / RWS 14%

Length – 15 m
Width – 1,1 m
Commercial packaging – 16,5 m²
package – 99 m²
Palette = 594 m²









Aluminium profiles

Universal perfection



Functional and aesthetic combination

Creating space and fitting out the interior of a house, home or office is the final stage of works, which provides finishing touches for the interior. It also influences our comfort. In order to meet the requirements of those who value both aesthetics and functionality, we offer you a wide range of aluminium profiles. Our rich assortment of aluminium profiles includes, transition skirtings boards, threshold skirtings boards and stair angles that perfectly complement arrangements of any interior. At the same time, they perfectly mask all joints and hide differences in height where floors connect.

	Article	Dimensionsv	Accessories	Installation recommendation	Page
Self-adhesive profiles	 DP 03 S	width 30 mm length 93 cm, 180 cm, 270 cm		self-adhesive skirtings board	86
	 DP 64 S	width 40 mm length 93 cm, 180 cm, 270 cm		self-adhesive skirtings board	86
	 DP 08 S	width 25 mm length 93 cm, 180 cm, 270 cm		self-adhesive skirtings board	87
	 DP 01 S	width 30 mm length 93 cm, 180 cm, 270 cm		self-adhesive skirtings board	87



Solidcore skirtings

System floor skirtings

Flexible floor skirtings

Stair profiles and auxiliary profiles

Woodem skirting

Kitchen worktop wall joint trims









Tools

Laminate underlays















Aluminium profiles









Racks – Displays









Self-adhesive profiles

	Article	Dimensions	Accessories	Installation recommendation	Page
	DP 11 S	width 39 mm length 93 cm, 180 cm, 270 cm		self-adhesive skirtings board	88
	DP 31 S	width 39 mm length 93 cm, 180 cm, 270 cm		self-adhesive skirtings board	88
	DP 36 S			self-adhesive skirtings board	89
	DP 63 S A/B/C			self-adhesive skirtings board	89

	Article	Dimensions	Accessories	Installation recommendation	Page	
Profiles for screws and bolts		DP 03	width 30 mm length 93 cm, 180 cm, 270 cm		Hammered plugs	90
		DP 66	width 50 mm length 93 cm, 180 cm, 270 cm		Hammered plugs	90
		DP 64	width 40 mm length 93 cm, 180 cm, 270 cm		Hammered plugs Screw	91
		DP 65	width 50 mm length 93 cm, 180 cm, 270 cm		Hammered plugs	91
		DP 08	width 35 mm length 93 cm, 180 cm, 270 cm		Hammered plugs Screw	92
		DP 70	width 40 mm length 90 cm		Hammered plugs Screw	92
		DP 71	width 58 mm length 250 cm		Hammered plugs Screw	93
		DP 01	width 30 mm length 93 cm, 180 cm, 270 cm		Hammered plugs Screw	93
		DP 31	width 25mm length 93 cm, 180 cm, 270 cm		Hammered plugs Screw	94
		DP 36	width 25mm height 20 mm length 93 cm, 180 cm, 270 cm		Hammered plugs Screw	94
		DP 33	width 40 mm height 20 mm length 93 cm, 180 cm, 270 cm		Hammered plugs Screw	95

	Article	Dimensions	Accessories	Installation recommendation	Page	
Profiles for professionals		Profi 1	width 33 mm, 46 mm length 100 cm		Trägerprofil E1, Trägerprofil E2	96
		Profi 2	width 56 mm length 100 cm, 250 cm		Trägerprofil E1, Trägerprofil E2	96
		Profi 3	width 32 mm length 100 cm, 250 cm		Trägerprofil E1, Trägerprofil E2	97
		Profi 4	width 32 mm length 100 cm height 12,5 mm, 27 mm		Trägerprofil E1, Trägerprofil E2	97
		Trägerprofile E1 und E2				97
		Profi 5	width 33,7 mm length 90 cm, 270 cm height 7-15 mm		Screw	98
		Profi 6			Screw	98

	Article	Dimensions	Accessories	Installation recommendation	Page
Profiles for professionals	 Profi 7	width 21,7 mm height 7-15 mm length 90 cm, 270 cm			99
	 Profi 8	width 24 mm length 90 cm, 270 cm			99
	 Profi 9	width 33 mm length 90 cm 270 cm			100
	 Profi 10	width 20 mm length 90 cm 270 cm			100

	Article	Dimensions	Accessories	Installation recommendation	Page
Plastic profiles	 Einfassleiste Einfach	width 32 mm height 5 mm length 100 cm			102
	 Single panel frame	width 35 mm height 5 mm length 100 cm			102
	 Double panel frame	width 35 mm height 2 mm length 100 cm			103
	 Covering strip	width 32 mm length 100 cm			103

DP 03 S

Self-adhesive standard transition profile

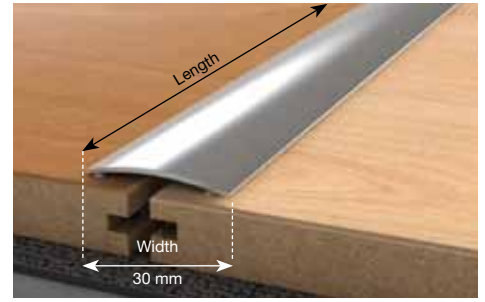

- anodized aluminium profiles resistant to abrasion
- enables levelling two different surfaces between 3 mm and 8 mm

Width:
30 mm

Hangers



Anodized Decors:



silver brushed inox golden champagne brown

Length:
93 cm
180 cm
270 cm

Lengths on request:
360 cm
450 cm

Veneered Decors:



white pine mocha oak oak cognac oak merbau beech red mahogany Japanese chestnut Indian teak

DP 64 S

Self-adhesive transition profiles

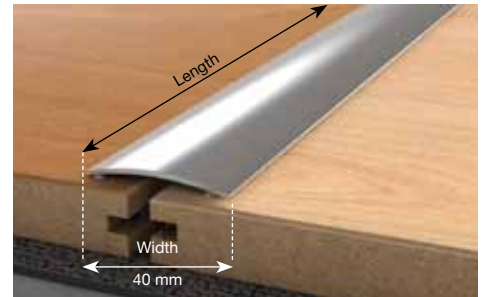

- flat, metal transition bus
- reliable, low-profile protection of carpet/PVC flooring edges from lifting, protecting the joint space between surfaces of panel floors
- it is particularly well suited for entrances and corridors
- lively and stable Decors due to the use of anodized aluminium of the highest quality

Width:
40 mm

Hangers



Length:
93 cm
180 cm
270 cm

Lengths on request:
360 cm
450 cm

Anodized Decors:



silver brushed inox golden champagne brown

Veneered Decors:



white pine mocha oak oak cognac oak merbau beech red mahogany Japanese chestnut Indian teak

DP 08 S

Corrugated transition profile – self-adhesive

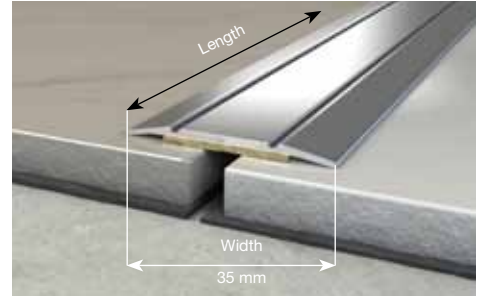

- hardened material, almost indestructible, resistant to walking and abrasions, stable colour
- cutting profiles using a metal fine-toothed saw

Anodized Decors:



silver brushed inox golden champagne brown

Veneered Decors:



white pine mocha oak oak cognac oak merbau beech red mahogany Japanese chestnut Indian teak

Width:
35 mm

Length:
93 cm
180 cm
270 cm

Lengths on request:
360 cm
450 cm

Hangers



DP 01 S

Finishing trim – self-adhesive

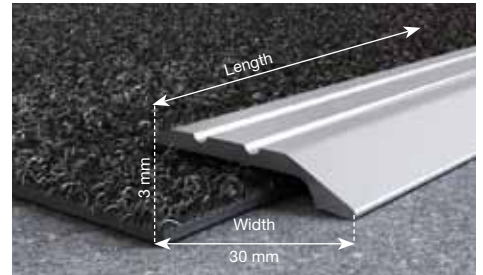

- anodized aluminium profiles resistant to abrasion
- enables levelling two different surfaces up to 3 mm

Anodized Decors:



silver brushed inox golden champagne brown

Veneered Decors:



white pine mocha oak oak cognac oak merbau beech red mahogany Japanese chestnut Indian teak

Width:
30 mm

Length:
90 cm
180 cm
270 cm

Lengths on request:
360 cm
450 cm

Hangers



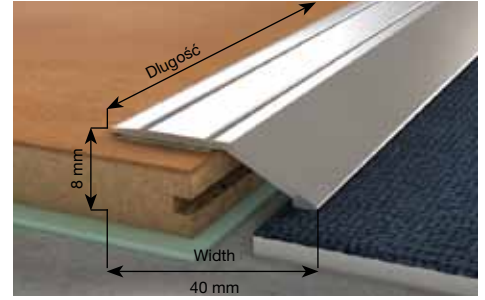

- anodized aluminium profiles resistant to abrasion
- enables levelling two different surfaces between 3 mm and 8 mm

Width:
40 mm

Length:
90 cm
180 cm
270 cm

Lengths on request:
360 cm
450 cm

Hangers



Anodized Decors:



Veneered Decors:

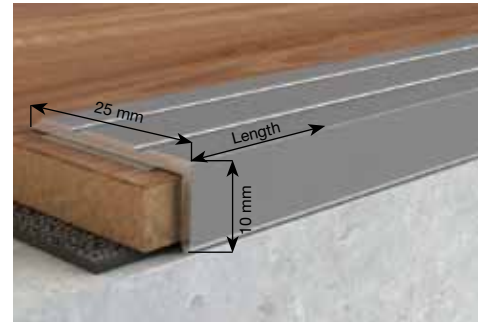
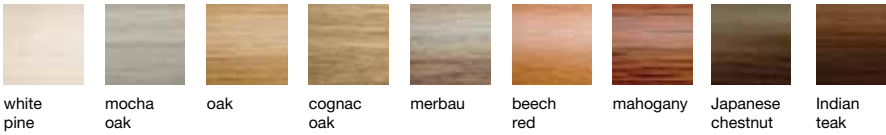

- plastic connecting rails
- anodised aluminium
- self-adhesive
- self-service packaging with installation manual

Width:
25 mm

Height:
10 mm

Length:
90 cm
180 cm
270 cm

Lengths on request:
360 cm
450 cm

Hangers



Anodized Decors:

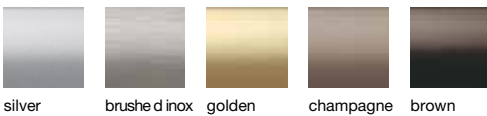

Veneered Decors:



DP 36 S

Angle for finishing stair step edges – self-adhesive

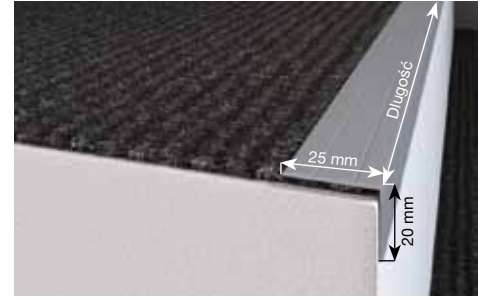

- robust stair angles made of anodised aluminium
- self-service packaging with installation manual
- long-term and reliable protection of the flooring and edges
- two grooves on the surface for more secure hold while using the stairs
- easy installation with screws
- fine metal saw for cutting to length
- 100 cm version includes screws and dowels

Anodized Decors:



silver brushed inox golden champagne brown

Width:
25 mm

Height:
20 mm

Length:
90 cm
180 cm
270 cm

Hangers



DP 63 S A/B/C

Finishing trim – self-adhesive

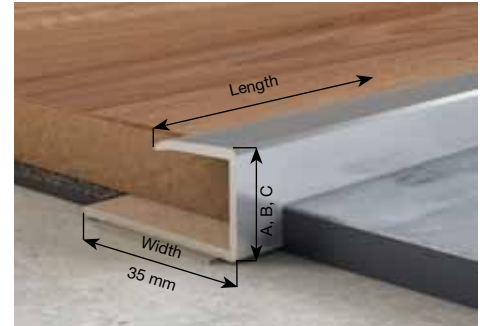

- plastic connecting rails
- anodised aluminium
- self-adhesive
- self-service packaging with installation manual

Anodized Decors:



silver brushed inox golden champagne brown

Width:
35 mm

Height:
A: 7–9mm
B: 10–12mm
C: 14–16mm

Length:
90 cm,
180 cm
270 cm

Lengths on request:
360 cm
450 cm

Hangers



DP 03

Standard transition profile

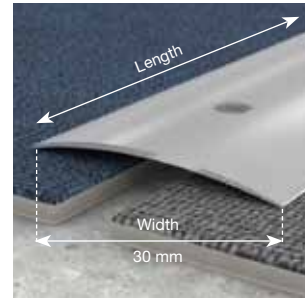

Installation:



Screw

- anodized aluminium
- self-adhesive profile — gel

Anodized Decors:



silver brushed inox golden champagne brown

Width:
30 mm

Length:
93 cm
180 cm
270 cm

Lengths on request:
360 cm
450 cm

Hangers



DP 66

Transition profile installed using plugs

Note!
Expansion

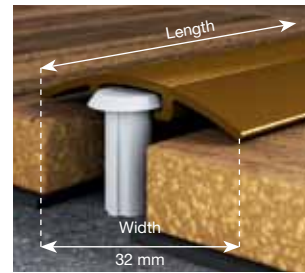

Installation:



Hammered plugs

- aesthetic transitions between surfaces of the floor
- anodized aluminium profiles resistant to abrasion
- easy installation using hammered plugs (included)
- smooth and aesthetic transitions, without protruding screws and risks they entail

Anodized Decors:



silver brushed inox golden champagne brown

Width:
32mm

Length:
93 cm
180 cm
270 cm

Lengths on request:
360 cm
450 cm

Hangers



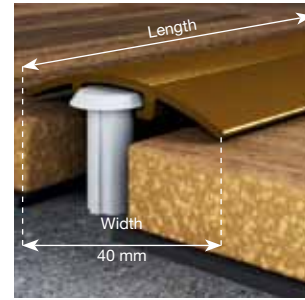
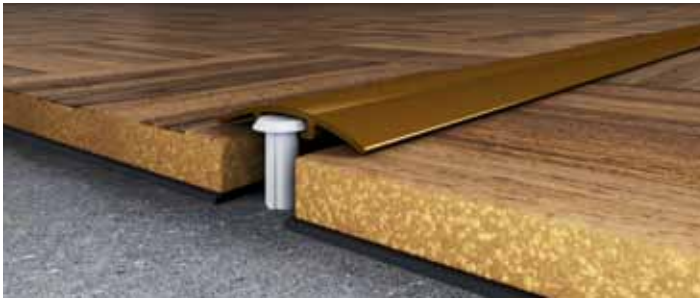

Installation:

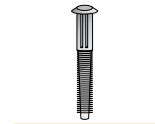

Hammered plugs

- flat, metal transition bus
- reliable, low-profile protection of carpet/PVC flooring edges from lifting, protecting the joint space between surfaces of panel floors
- it is particularly well suited for entrances and corridors
- lively and stable Decors due to the use of anodized aluminium of the highest quality
- available with openings for plugs (included), or in self-adhesive form
- the highest quality, durability and easy installation

Width:
40 mm

Length:
93 cm
180 cm
270 cm

Lengths on request:
360 cm
450 cm

Hangers



Anodized Decors:



silver brushed inox golden champagne brown

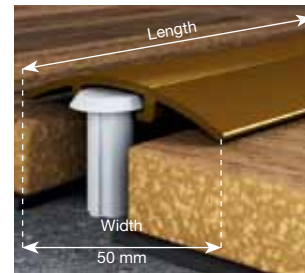

Installation:

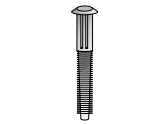

Hammered plugs

- flat, metal transition bus
- it is particularly well suited for entrances and corridors
- lively and stable Decors due to the use of anodized aluminium of the highest quality
- the highest quality, durability and easy installation

Width:
50 mm

Length:
93 cm
180 cm
270 cm

Lengths on request:
360 cm
450 cm

Hangers



Anodized Decors:



silver brushed inox golden champagne brown

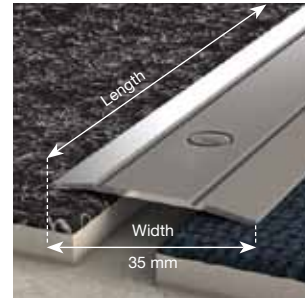
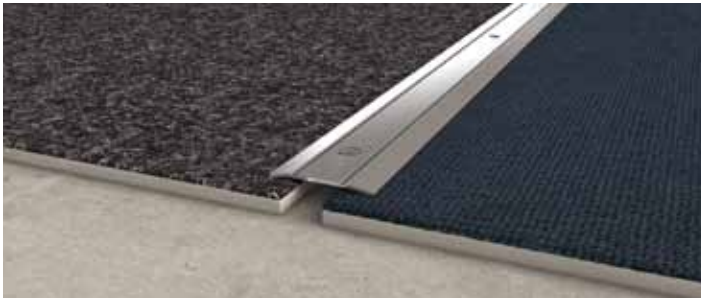

Installation:



Screw

- flat, metal transition bus
- reliable, low-profile protection of carpet/PVC flooring edges from lifting
- it is particularly well suited for entrances and corridors
- lively and stable Decors due to the use of anodized

Width:
35 mm

Length:
93 cm
180 cm
270 cm

Lengths on request:
360 cm
450 cm

Hangers



Anodized Decors:



silver brushed inox golden champagne brown



A kink to fit to the floor height with millimetre precision

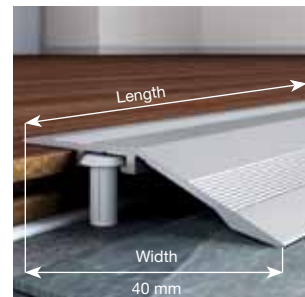

Installation:



Single dowel

Consider expansion joints

- compensating rails made of anodised aluminium
- high level of tread resistance
- Give parquets and laminate floors a high-quality finish with invisible fixing
- simple installation with single dowels

Width:
40 mm

Length:
90 cm
250 cm

Hangers



Anodized Decors:



silver brushed inox golden champagne

DP 71

Standard Dowels For Compensating Profiles



Consider expansion joints

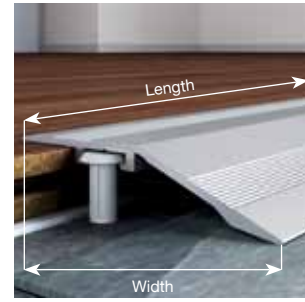

Installation:

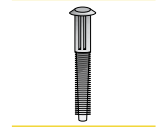

Single dowel

- compensating rails made of anodised aluminium
- high level of tread resistance
- Give parquets and laminate floors a high-quality finish with invisible fixing
- simple installation with single dowels

Width:
58 mm

Length:
90 cm
250 cm

Hangers



Anodized Decors:



DP 01

Finishing trim



Installation:



Screw

- anodized aluminium profiles resistant to abrasion
- enables levelling two different surfaces up to 3 mm

Width:
30 mm

Length:
90 cm
180 cm
270 cm

Hangers



Anodized Decors:

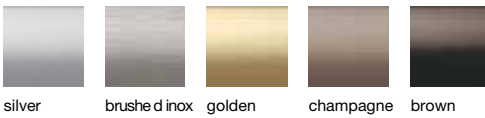

Lengths on request:
360 cm
450 cm

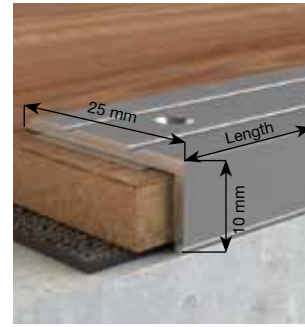

Installation:



Screw

- plastic connecting rails
- anodised aluminium
- self-adhesive
- self-service packaging with installation manual

Anodized Decors:



silver brushed inox golden champagne brown

Width:

25 mm

Height:

10 mm

Length:

90 cm
180 cm
270 cm

Lengths on request:

360 cm
450 cm

Hangers

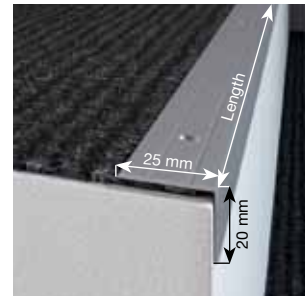

Installation:



Screw

- robust stair angles made of anodised aluminium
- self-service packaging with installation manual
- long-term and reliable protection of the flooring and edges
- two grooves on the surface for more secure hold while using the stairs
- easy installation with screws
- fine metal saw for cutting to length
- 100 cm version includes screws and dowels

Anodized Decors:



silver brushed inox golden champagne brown

Width:

25mm

Height:

20 mm

Length:

90 cm
180 cm
270 cm

Hangers



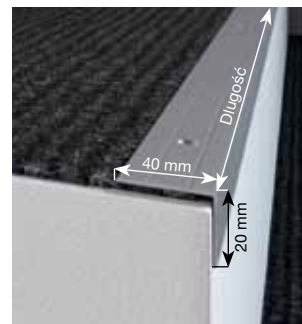

Installation:



Screw

- robust stair angles made of anodised aluminium
- self-service packaging with installation manual
- long-term and reliable protection of the flooring and edges
- two grooves on the surface for more secure hold while using the stairs
- two grooves on the surface for more secure hold when using the stairs
- easy installation with screws
- fine metal saw for cutting to length
- 100 cm version includes screws and dowels

Anodized Decors:



silver brushed inox golden champagne brown

Width:

40 mm

Height:

20 mm

Length:

90 cm

180 cm

270 cm

Hangers



Profi 1 A/B

Clip – Transition Profile



A kink to fit to the floor height with millimetre precision

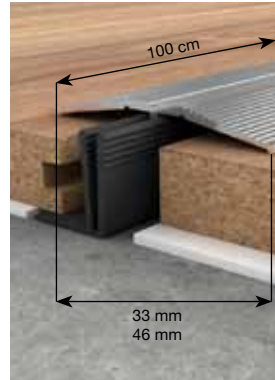

Installation:



E1
6,5–15 mm

E2
14–22 mm

Consider expansion joints

- Easy and precise installation due to a two-part Clip- System with a stable plastic base profile
- later on the profiles are easily removable e.g. during refurbishment works
- supporting profile available separately
- Including screws and dowels

Width:

A: 33mm
B: 46mm

Length:

100 cm
250 cm

Hangers



Anodized Decors:

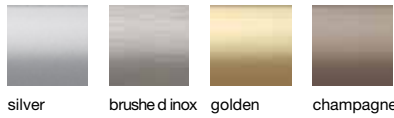

silver brushed inox golden champagne

Profi 2

Compensating Clip Profile



A kink to fit to the floor height with millimetre precision

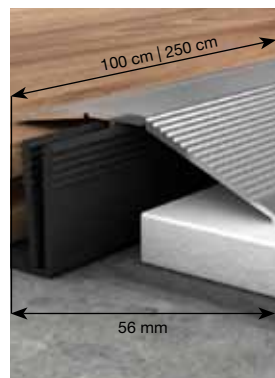

Installation:



E1
6,5–15 mm

E2
14–22 mm

Consider expansion joints

- Easy and precise installation due to a two-part Clip-System with a stable plastic base profile
- plastic base profile available in two heights
- later on the profiles are easily removable e.g. during refurbishment works
- anodised aluminium
- supporting profile available separately
- fine metal saw for cutting to length
- 100 cm version includes screws and dowels

Width:

56 mm

Length:

100 cm
250 cm

Hangers



Anodized Decors:

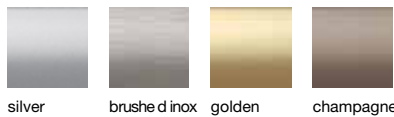

silver brushed inox golden champagne

Profi 3

Clip – Finishing Trim



A kink to fit to the floor height with millimetre precision

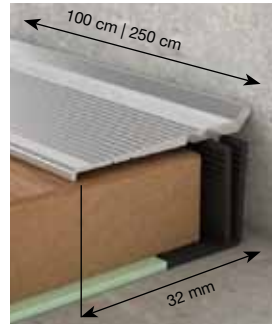

Installation:



E1
6,5–15 mm

E2
14–22 mm

Consider expansion joints

- Easy and precise installation due to a two-part Clip-System with a stable plastic base profile
- later on the profiles are easily removable e.g. during refurbishment works
- anodised aluminium
- supporting profile available separately
- fine metal saw for cutting to length
- 100 cm version includes screws and dowels

Width:
32 mm

Length:
100 cm
250 cm

Hangers



Anodized Decors:

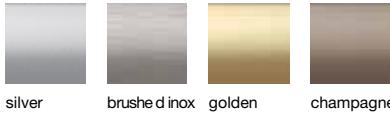

silver brushed inox golden champagne

Profi 4

Clip – Angle for finishing stair step edges



A kink to fit to the floor height with millimetre precision

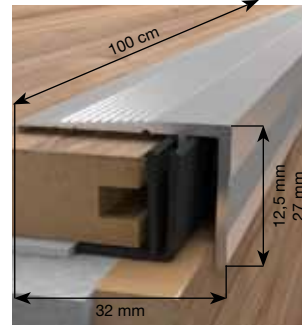

Installation:



E1
6,5–15 mm

E2
14–22 mm

Consider expansion joints

- Easy and precise installation due to a two-part Clip-System with a stable plastic base profile
- later on the profiles are easily removable e.g. during refurbishment works
- anodised aluminium
- supporting profile available separately
- Including screws and dowels

Width:
32mm

Length:
100 cm

Height:
12.5 mm
27 mm

Hangers



Anodized Decors:



silver brushed inox golden champagne

Girder E1 and E2

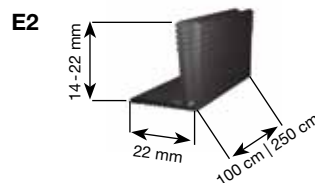
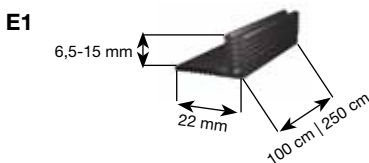

- for Clip profile
- high-quality plastic
- easy to screw to the floor
- easily removable
- available length: 1 m and 2.5 m

Profi 5

Premium Transition Profiles



A kink to fit to the floor height with millimetre precision

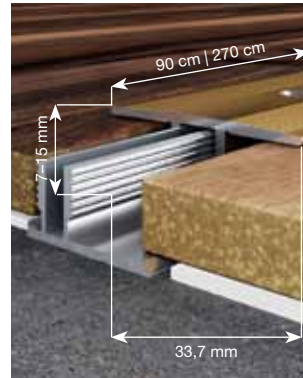

Installation:



Screw

Consider expansion joints

- Anodized aluminium, resistant to walking
- Aesthetic transitions between floors or panels
- Transition profiles protect both floor finishing trims, and hide skewed edges
- Top profile is easy to install and fixed to the base profile using bolts
- When laying the floor or panels, consider an appropriate expansion joint

Width:
33.7mm

Length:
90 cm
270 cm

Height:
7-15 mm

Hangers



Anodized Decors:



silver brushed inox golden champagne brown

Profi 6

Premium Compensating Profiles



A kink to fit to the floor height with millimetre precision

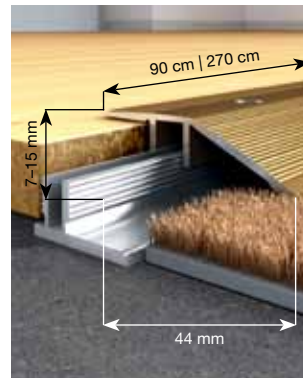

Installation:



Screw

Consider expansion joints

- Anodized aluminium, resistant to walking
- Clean connection of floor and panels 7-15 mm thick, with lower floor or flooring, e.g. carpet or PCV
- Profile arms are flexible, they automatically adjust to the required height of adjoining floor when screwing in the top profile to the base profile.

Width:
44 mm

Length:
90 cm
270 cm

Height:
7-15 mm

Hangers



Anodized Decors:

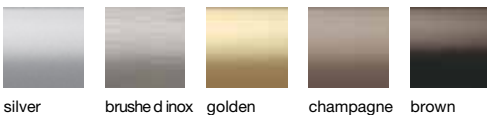

silver brushed inox golden champagne brown

Profi 7

Premium End Profiles



A kink to fit to the floor height with millimetre precision

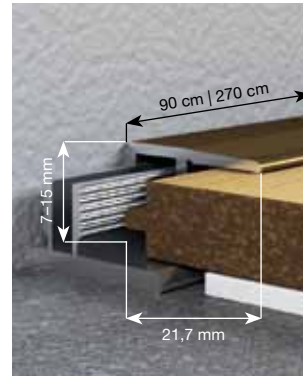

Installation:



Screw

Consider expansion joints

- Anodized aluminium, resistant to walking
- Clean finishing trims of floors and panels 7-15 mm thick, near doorsteps, tiles, terrace doors and windows, as well as other higher floors
- Top profile is easy to install and fixed to the base profile using bolts
- It facilitates hiding skewed edges

Anodized Decors:



Width:

21.7 mm

Length:

90 cm

270 cm

Height:

7-15 mm

Hangers



Profi 8

Expert Design Transition Profiles

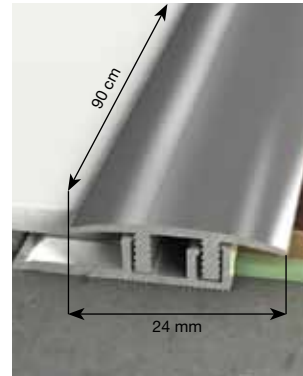

Installation:



Screw

- tread-resistant anodised aluminium
- designed especially for luxury floors of 4-7.5 mm
- Included screws and dowels

Anodized Decors:

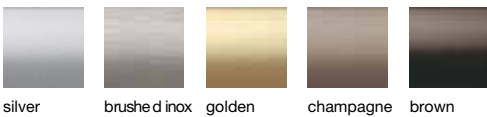

Width:

24 mm

Length:

90 cm

270 cm

Hangers



Profi 9

Expert Design Compensating Profiles

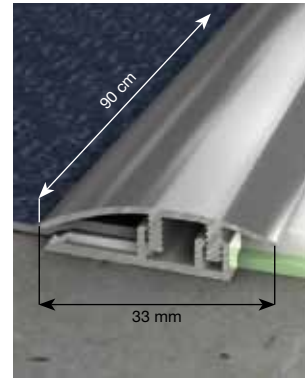
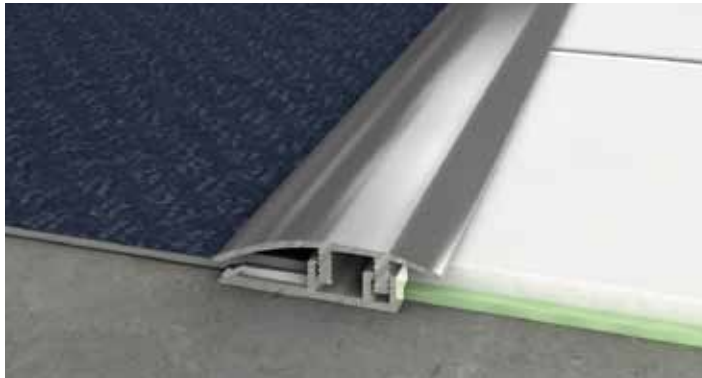

Installation:



Screw

- tread-resistant anodised aluminium
- designed especially for luxury floors of 4-7.5 mm
- includes screws and dowels

Anodized Decors:

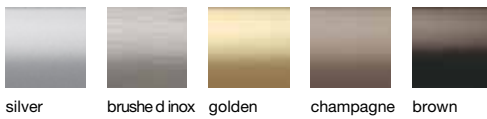

silver brushed inox golden champagne brown

Width:

33 mm

Length:

90 cm

270 cm

Hangers



Profi 10

Expert Design End Profiles

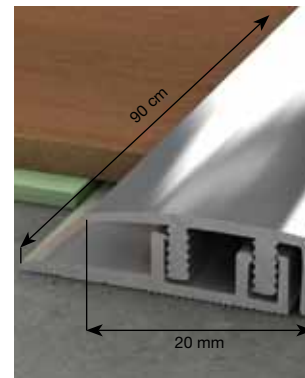
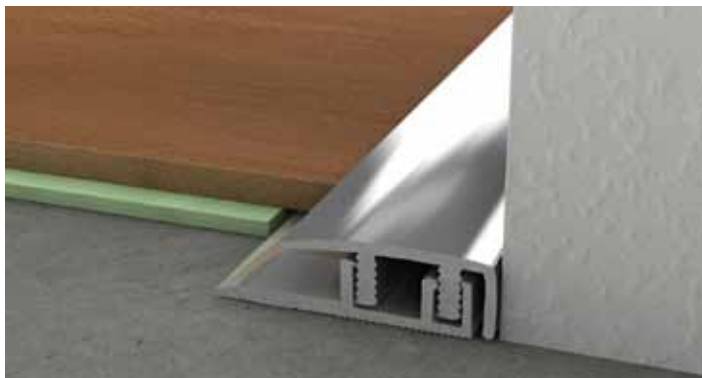

Installation:



Screw

- tread-resistant anodised aluminium
- designed especially for luxury floors of 4-7.5 mm
- includes screws and dowels

Anodized Decors:

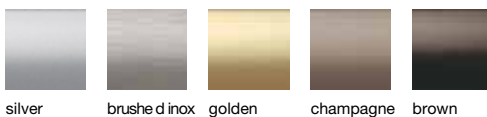

silver brushed inox golden champagne brown

Width:

20 mm

Length:

90 cm

270 cm

Hangers





Single panel frame

Self-adhesive profiles

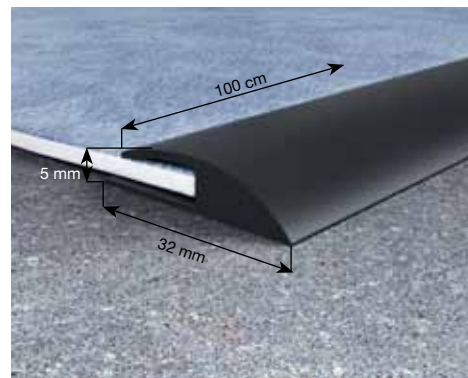

- flexible adjustment to PVC and carpeted floorings with material thickness of 3-5 mm due to elastic soft protective rubber edges
- coverage of rough edges
- extremely easy to cut with a carpet knife or suitable scissors
- simple installation without tools due to the bottom layer of self-adhesive coating
- elastic plastic
- self-adhesive
- self-service packaging with installation manual

Width:

32 mm

Length:

100 cm

Height:

5 mm

Hangers



Decors:



brown

brown-beige grey

black

Single panel frame

Self-adhesive profiles

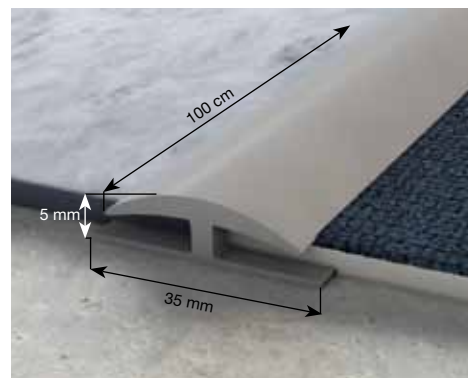

- flexible adjustment to PVC and carpeted floorings with material thickness of 3-5 mm due to elastic soft protective rubber edges
- coverage of rough edges
- extremely easy to cut with a carpet knife or suitable scissors
- simple installation without tools due to the bottom layer of self-adhesive coating
- elastic plastic
- self-adhesive
- self-service packaging with installation manual

Width:

35 mm

Length:

100 cm

Height:

5 mm

Hangers



Decors:



brown

brown-beige grey-beige

grey

black

Double panel frame

Self-adhesive profiles

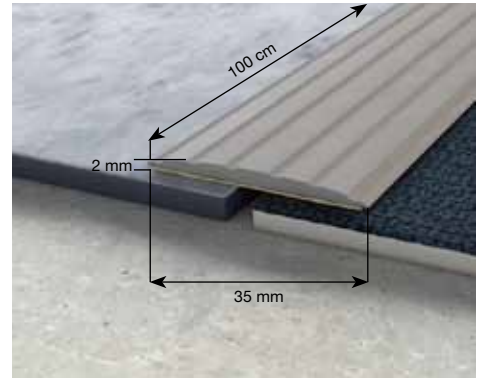
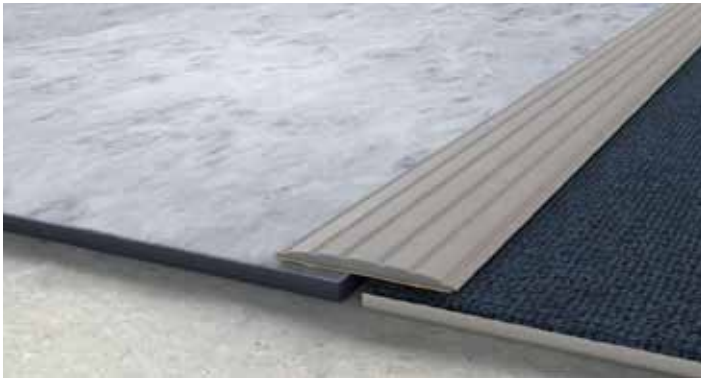

- flexible adjustment to PVC and carpeted floorings with material thickness of 3-5 mm due to elastic soft protective rubber edges
- coverage of rough edges
- extremely easy to cut with a carpet knife or suitable scissors
- simple installation without tools due to the bottom layer of self-adhesive coating
- elastic plastic
- self-adhesive
- self-service packaging with installation manual

Width:
35 mm

Length:
100 cm

Height:
2 mm

Hangers



Decors:



brown brown-beige grey

Plastic Transition Rails

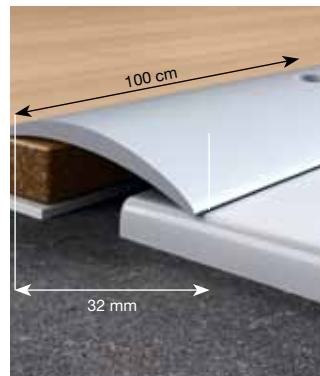

Installation:



Screw

- robust transition strip made of extra-hard plastic
- possibility to cut to size with a fine saw
- easy to screw with the attached screws and dowels
- rough edges of the floor are covered and the transition is permanently protected
- flexible design due to a great variety of Decors
- hard plastic
- self-service packaging with installation manual
- includes screws and dowels in matching Decors

Width:
32 mm

Length:
100 cm

Hangers





Decors:



white messing brown brown-beige grey-beige grey black

Racks — displays



	Product	Content	Page
	STANDARD		105
	ALUMINIUM		105



Solidcore skirtings

System floor skirtings

Flexible floor skirtings

Stair profiles and auxiliary profiles

Woodem skirting

	Product	Content	Page
	DISPLAY — MIG 8 PS		107
	DISPLAY — MIH 15 PH		107
	DISPLAY — DEMO		108
	DISPLAY — CUBU FLEX LIFE		109

Kitchen worktop wall joint trims

Tools

Laminate underlays

Aluminium profiles

Racks – Displays

STANDARD



ALUMINIUM

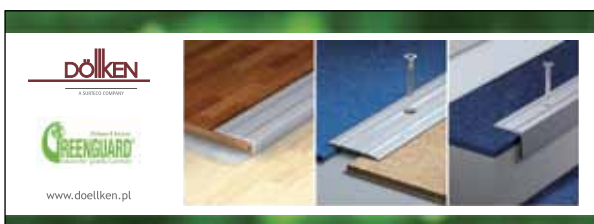
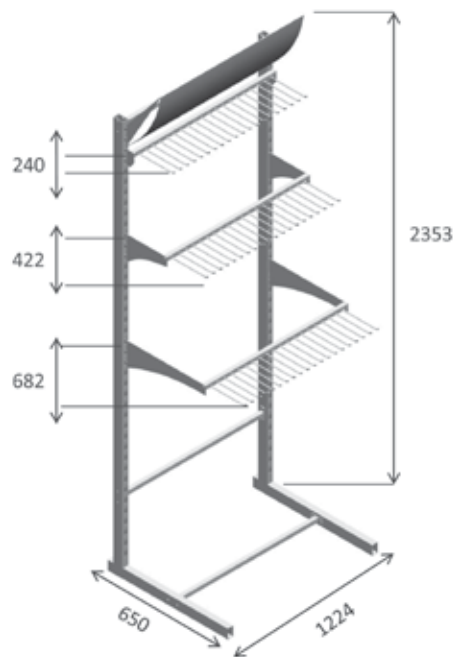
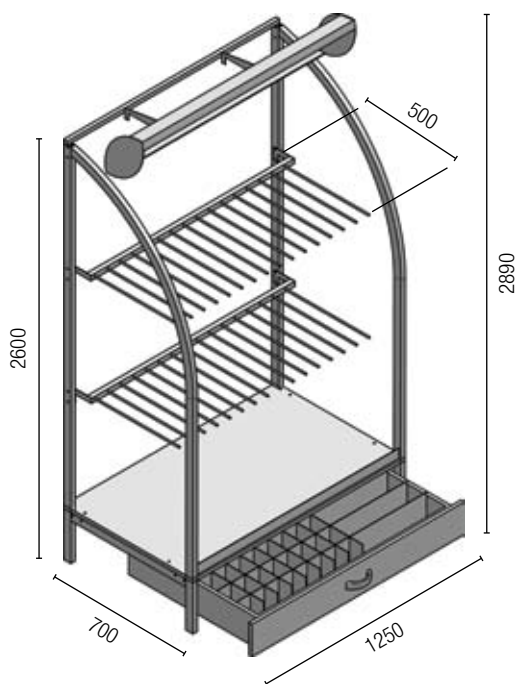

DISPLAY — MIG 8 PS



DISPLAY — MIH 15 PH

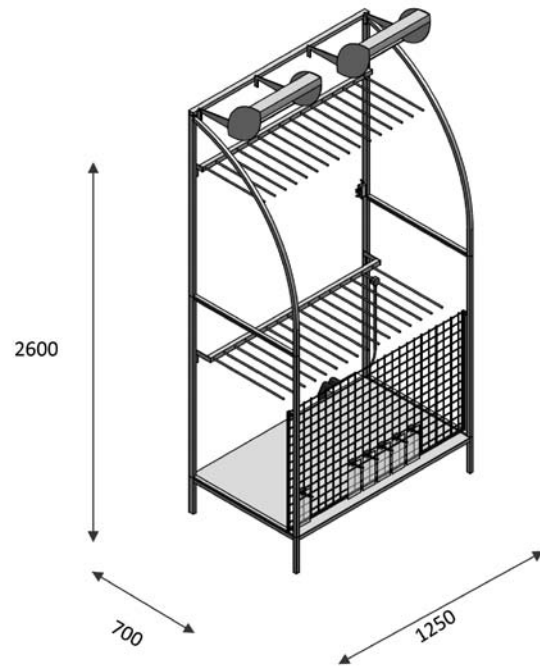
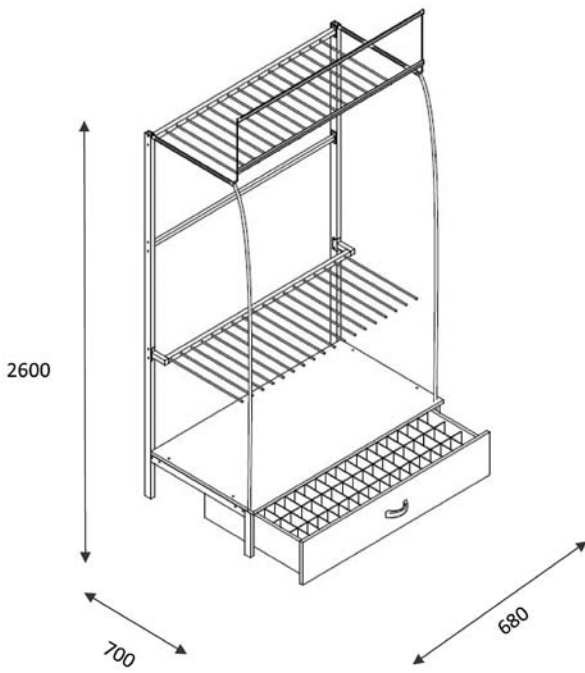



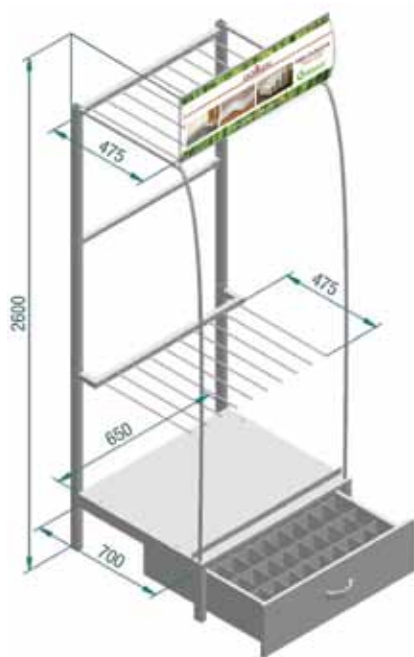

DÖLLEN
A SIBIRCO COMPANY

CUBU FLEX LIFE
Listwa do wszystkich rodzajów podłóg

GREENGUARD
LOW VOC FORMULA

www.doellen.pl

